

CODE	COURSE NAME	CATEGORY	L	T	P	CREDIT
EET401	ADVANCED CONTROL SYSTEMS	PCC	2	1	0	3

Preamble: This course aims to provide a strong foundation on advanced control methods for modelling, time domain analysis, and stability analysis of linear and nonlinear systems. The course also includes the design of feedback controllers and observers.

Prerequisite: EET 305 Signals and Systems, EET 302 Linear Control Systems

Course Outcomes: After the completion of the course the student will be able to:

CO 1	Develop the state variable representation of physical systems
CO 2	Analyse the performance of linear and nonlinear systems using state variable approach
CO 3	Design state feedback controller for a given system
CO 4	Explain the characteristics of nonlinear systems
CO 5	Apply the tools like describing function approach or phase plane approach for assessing the performance of nonlinear systems
CO 6	Apply Lyapunov method for the stability analysis of physical systems.

Mapping of course outcomes with program outcomes

	PO 1	PO 2	PO 3	PO 4	PO 5	PO 6	PO 7	PO 8	PO 9	PO 10	PO 11	PO 12
CO 1	3	3	-	-	-	-	-	-	-	-	-	2
CO 2	3	3	2	-	-	-	-	-	-	-	-	2
CO 3	3	3	3	-	-	-	-	-	-	-	-	2
CO 4	3	2	-	-	-	-	-	-	-	-	-	2
CO 5	3	3	2	-	-	-	-	-	-	-	-	2
CO 6	3	3	2	-	-	-	-	-	-	-	-	2

Assessment Pattern:

Total Marks	CIE marks	ESE marks	ESE Duration
150	50	100	03 Hrs

Bloom's Category	Continuous Assessment Tests		End Semester Examination
	1	2	
Remember (K1)	10	10	20
Understand (K2)	15	15	30
Apply (K3)	25	25	50
Analyse (K4)			
Evaluate (K5)			
Create (K6)			

End Semester Examination Pattern: There will be two parts; Part A and Part B.

Part A contains 10 questions with 2 questions from each module, having 3 marks for each question. Students should answer all questions.

Part B contains 2 questions from each module of which student should answer any one. Each question carries 14 marks and can have maximum 2 sub-divisions.

Course Level Assessment Questions:

Course Outcome 1 (CO1)

1. Derive the state model of an armature controlled DC servo motor. (K2, PO1)
2. Obtain the phase variable representation for the system with $G(s)=$

$$T(s) = \frac{2s^2 + s + 3}{s^3 + 6s^2 + 11s + 6} \quad (\text{K3, PO1, PO2})$$

3. Problems on deriving the state model of a given electrical circuit. (K2, PO1)
4. Problems on the conversion of Phase variable form to Canonical form. (K3, PO1, PO2)

Course Outcome 2 (CO2):

1. Obtain the time response $y(t)$ of the homogeneous system:

$$\dot{X} = \begin{bmatrix} -1 & 1 \\ -2 & -3 \end{bmatrix} x, \quad y = [1 \quad 1]x \quad \text{and} \quad x(0)^T = [1 \quad 0] \quad (\text{K3, PO1, PO2})$$

2. Determine the transfer function for the system with the state model:

$$\dot{X} = \begin{bmatrix} -2 & 1 \\ -3 & -2 \end{bmatrix} x + \begin{bmatrix} 1 \\ 1 \end{bmatrix} u; \quad y = [1 \quad 1]x \quad (\text{K3, PO1, PO2})$$

3. Determine the controllability of the following state model:

$$\dot{x} = \begin{bmatrix} 1 & 0 & 0 \\ 0 & 0 & 2 \\ 0 & -1 & -5 \end{bmatrix} x + \begin{bmatrix} 0 \\ 0 \\ 1 \end{bmatrix} u \quad (\text{K3, PO1, PO2, PO3})$$

Course Outcome 3(CO3):

1. Design a state feedback controller for the following system such that the closed loop poles are placed at: $-1 \pm j2$ and -12 .

$$\dot{x} = \begin{bmatrix} 0 & 1 & 0 \\ 0 & -1 & 2 \\ 0 & -1 & -3 \end{bmatrix} x + \begin{bmatrix} 0 \\ 0 \\ 1 \end{bmatrix} u \quad (\text{K3, PO1, PO2, PO3})$$

2. Design problems on State observer. (K3, PO1, PO2, PO3)

Course Outcome 4 (CO4):

1. Explain the linearization concept and assumptions made referred to Describing Function analysis. (K1, PO1)
2. With suitable characteristics explain the jump resonance phenomena. (K2, PO1, PO2)
3. Differentiate between linear and nonlinear systems referred to:
 - i) frequency response, ii) sustained oscillations. (K2, PO1, PO2)
4. Identify and explain the type of singular points for the following two systems:

$$\text{i) } \dot{X} = \begin{bmatrix} 0 & 1 \\ -2 & 3 \end{bmatrix} X \quad \text{and} \quad \text{ii) } \dot{X} = \begin{bmatrix} 0 & 1 \\ -1 & -2 \end{bmatrix} X \quad (\text{K3, PO1, PO2})$$

Course Outcome 5 (CO5):

1. Problems related to the derivation of describing function of a common nonlinearity. (K2, PO1, PO2)
2. Problems related to application of describing function for analysing the stability of given closed loop system. (K3, PO1, PO2, PO3)
3. Obtain the phase trajectory of the system with $\ddot{y} + 6\dot{y} + 5y = 0$, for initial point $x(0)^T = [1 \ 0.6]$. Use Isocline method. Also, identify the type of singular point. (K3, PO1, PO2, PO3)

Course Outcome 6 (CO6):

1. Use Lyapunov Direct method to determine the value of K such that the given LTI system is stable.

$$\dot{X} = \begin{bmatrix} 0 & K \\ -2 & -1 \end{bmatrix} X \quad . \quad (\text{K3, PO1, PO2, PO3})$$

$$\dot{X} = \begin{bmatrix} 0 & 1 & 0 \\ 0 & 0 & 1 \\ -1 & -2 & -5 \end{bmatrix} X$$

2. Determine the stability of the LTI system with state model:
(K3, PO1, PO2, PO3)
3. Test stability of the nonlinear system given below, using Lyapunov method.

$$\dot{X} = \begin{bmatrix} -4 & 0 \\ 3x_2^2 & -2 \end{bmatrix} X \quad (\text{K3, PO1, PO2, PO3})$$

Estd.



2014

Model Question Paper

PAGES: 3

QP CODE:

Reg.No: _____

Name: _____

APJ ABDULKALAM TECHNOLOGICAL UNIVERSITY
SEVENTH SEMESTER B.TECH DEGREE EXAMINATION
MONTH & YEAR

Course Code: EET401

Course Name: **ADVANCED CONTROL SYSTEMS****Max. Marks: 100****Duration: 3 Hours****PART A****Answer all Questions. Each question carries 3 Marks**

1 Selecting $i_1(t) = x_1(t)$ and $i_2(t) = x_2(t)$ as state variables obtain state equation and output equation of the network shown.

2 Obtain the diagonal canonical representation for the system with the transfer function:

$$T(s) = \frac{s + 2}{s^2 + 0.7s + 0.1}$$

3 Determine the transfer function for the system with state model:

$$\dot{X} = \begin{bmatrix} -2 & 1 \\ 0 & -2 \end{bmatrix} x + \begin{bmatrix} 2 \\ 0 \end{bmatrix} u; \quad y = [1 \quad 0]x$$

4 Explain any four properties of state transition matrix.

5 Determine the controllability of the following state model:

$$\dot{x} = \begin{bmatrix} 1 & 0 & 0 \\ 0 & 2 & 1 \\ 0 & -1 & -5 \end{bmatrix} x + \begin{bmatrix} 0 \\ 0 \\ 1 \end{bmatrix} u$$

6 Explain the significance of PBH test for observability.

7 With suitable characteristics explain the jump resonance phenomena in nonlinear systems.

8 Obtain the describing function of deadzone non-linearity.

9 Determine given quadratic form is positive definite or not:

$$V(x) = 10x_1^2 + 4x_2^2 + x_3^2 + 2x_1x_2 - 2x_2x_3 - 4x_1x_3$$

10 Use Lyapunov theorem to determine test stability of the nonlinear system given below.

$$\dot{X} = \begin{bmatrix} -4 & 0 \\ 3x_2^2 & -2 \end{bmatrix} X$$

PART B**Answer any one full question from each module. Each question carries 14 Marks****Module 1**

11 a) Obtain the phase variable representation for the system with transfer function:

$$T(s) = \frac{2s^2 - 3}{s^3 + 6s^2 + 11s + 6}$$

(7 Marks)

b) Derive the state model of an armature controlled DC servo motor.

(7 Marks)

12 a) Determine the diagonal canonical representation for the system:

$$\dot{X} = \begin{bmatrix} -2 & 1 \\ -3 & -2 \end{bmatrix} x + \begin{bmatrix} 1 \\ 0 \end{bmatrix} u; \quad y = [1 \quad -1]x. \quad (9 \text{ Marks})$$

- b) Explain any four advantages of state model as compared to transfer function model. (5 Marks)

Module 2

- 13 a) Obtain the unit step response $y(t)$ of the system

$$\dot{X} = \begin{bmatrix} -1 & 0 \\ -2 & -3 \end{bmatrix} x + \begin{bmatrix} 1 \\ 1 \end{bmatrix} u, \quad y = [1 \quad 1]x. \quad (10 \text{ Marks})$$

- b) Show that eigen values of state models are unique. (4 Marks)

- 14 a) Determine the state transition matrix for the system with state model:

$$\dot{X} = \begin{bmatrix} -1 & 1 \\ 1 & -2 \end{bmatrix} x \quad (7 \text{ Marks})$$

- b) How do you derive the z transfer function from the state model of a sampled data system? (7 Marks)

Module 3

- 15 a) Consider a linear system described by the transfer function $\frac{Y(s)}{U(s)} = \frac{10}{s(s+1)(s+2)}$. Design a feedback controller with a state feedback so that the closed loop poles are placed at $-2, -1 \pm j1$. (10 Marks)

- b) Write short note on reduced order observer. (4 Marks)

- 16 a)
$$\dot{x} = \begin{bmatrix} 1 & 2 & 0 \\ 3 & -1 & 1 \\ 0 & 2 & -5 \end{bmatrix} x + \begin{bmatrix} 2 \\ 1 \\ 1 \end{bmatrix} u$$

Consider a linear system described by

Design a state observer so that the closed loop poles are placed at $-4, -3 \pm j1$. (9 Marks)

- b) With suitable example explain the concept of duality referred to controllability. (5 Marks)

Module 4

- 17 a) Determine the value of K for an occurrence of limit cycle. Also determine the amplitude, frequency and stability of limit cycle. (10 Marks)

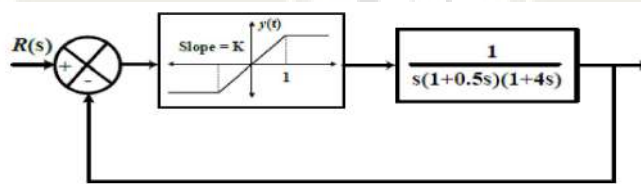

- b) With relevant characteristics explain any three nonlinearities in electrical systems. (4 Marks)

- 18 a) Obtain the describing function of relay with dead zone nonlinearity. (8 Marks)
 b) Explain the linearization concept and assumptions made referred to Describing Function analysis. (6 Marks)

Module 5

- 19 a) A linear second order system is described by the equation: $\ddot{e} + 2\delta\omega_n\dot{e} + \omega_n^2 e = 0$, with $\delta = 0.25$, $\omega_n = 1 \text{ rad/sec}$, $e(0) = 1.0$, and $\dot{e}(0) = 0$. Determine the singular point and state the stability by constructing the phase trajectory using the method of isoclines. (11 Marks)
 b) Identify and explain the type of singular point for the following system:

$$\dot{X} = \begin{bmatrix} 0 & 1 \\ -2 & 3 \end{bmatrix} X$$

(3 Marks)

- 20 a) Differentiate between stable and unstable limit cycles. (5 Marks)
- b) Use Lyapunov Direct method to determine the value of K such that the given LTI system is stable.

$$\dot{X} = \begin{bmatrix} 0 & K \\ -2 & -1 \end{bmatrix} X$$

(9 Marks)

Syllabus

Module 1

State Space Representation of Systems (7 hours)

Introduction to state space and state model concepts- State equation of linear continuous time systems, matrix representation- features- Examples of electrical circuits and dc servomotors. Phase variable forms of state representation- Diagonal Canonical forms- Similarity transformations to diagonal canonical form.

Module 2

State Space Analysis (9 hours)

State transition matrix- Properties of state transition matrix- Computation of state transition matrix using Laplace transform and Cayley Hamilton method.

Derivation of transfer functions from state equations.

Solution of time invariant systems: Solution of time response of autonomous systems and forced systems.

State space analysis of Discrete Time control systems: Phase variable form and Diagonal canonical form representations- Pulse transfer function from state matrix- Computation of State Transition Matrix (problems from 2nd order systems only).

Module 3

State Feedback Controller Design (6 hours)

Controllability & observability: Kalman's, Gilbert's and PBH tests.- Duality principle

State feedback controller design: State feed-back design via pole placement technique

State observers for LTI systems- types- Design of full order observer.

Module 4

Nonlinear Systems (7 hours)

Types and characteristics of nonlinear systems- Jump resonance, Limit cycles and Frequency entrainment

Describing function method: Analysis through harmonic linearization- Determination of describing function of nonlinearities.

Application of describing function for stability analysis of autonomous system with single nonlinearity (relay, dead zone and saturation only).

Module 5

Phase Plane and Lyapunov Stability Analysis (8 hours)

Phase plots: Concepts- Singular points – Classification of singular points.

Definition of stability- asymptotic stability and instability.

Construction of phase trajectories using Isocline method for linear and nonlinear systems.

Lyapunov stability analysis: Lyapunov function- Lyapunov methods to stability of nonlinear systems- Lyapunov methods to LTI continuous time systems.

Text Books:

1. Nagarath I. J. and Gopal M., Control System Engineering, 5/e, New Age Publishers, 2007
2. Ogata K., Modern Control Engineering, 5/e, Prentice Hall of India, 2010.
3. Gopal M, Modern Control System Theory, 2/e, New Age Publishers, 1984
4. Kuo B.C, Analysis and Synthesis of Sampled Data Systems, Prentice Hall Publications, 2012.

References:

1. Khalil H. K, Nonlinear Systems, 3/e, Prentice Hall, 2002
2. Gibson J.E. Nonlinear Automatic Control, Mc Graw Hill, 1963.
3. Gopal M., Control Systems Principles and Design, 4/e, Tata McGraw Hill, 2012.
4. Slotine J. E and Weiping Li, Applied Nonlinear Control, Prentice-Hall, 1991,
5. Gopal M, Digital Control and State Variable Methods, 2/e, Tata McGraw Hill, 2003
6. Thomas Kailath, Linear Systems, Prentice-Hall, 1980.
7. Ogata K., Discrete Time Control Systems, 2/e, Pearson Education, Asia, 2015

Course Contents and Lecture Schedule:

No	Topic	No. of Lectures
1	State Space Representation of Systems	(7 hours)
1.1	Introduction to state space and state model concepts- state equation of linear continuous time systems, matrix representation- features -Examples of electrical circuits and dc servomotors	3
1.2	Phase variable forms of state representation- features- controllable and observable companion forms	2
1.3	Diagonal canonical forms of state representation- Diagonal & Jordan forms- features- Similarity transformations to diagonal canonical form	2
2	State Space Analysis	(9 hours)
2.1	State transition matrix- Properties of state transition matrix- Computation of state transition matrix using Laplace transform- Cayley Hamilton method.	2
2.2	Derivation of transfer functions from state equations.	1
2.3	Solution of time invariant systems: Solution of time response of autonomous systems and forced systems	3
2.4	State space analysis of Discrete Time control systems: Phase variable form and Diagonal canonical form representations	2
2.5	Pulse transfer function from state matrix- Computation of State Transition Matrix- (problems from 2 nd order systems only)	1
3	State Feedback Controller Design	(6 hours)
3.1	Controllability & observability: Kalman's, Gilbert's and PBH tests- Duality property	2
3.2	State feedback controller design: State feed-back design via pole placement technique	2

3.3	State observers for LTI systems- Full order and reduced order observers- Design of full order observer design	2
4	Nonlinear Systems	(7 hours)
4.1	Types of nonlinear systems- characteristics of nonlinear systems- peculiar features like Jump resonance, Limit cycles and Frequency entrainment	2
4.2	Describing function Method: Analysis through harmonic linearisation	1
4.3	Determination of describing function of nonlinearities	2
4.4	Application of describing function for stability analysis of autonomous system with single nonlinearity (relay, dead zone and saturation only).	2
5	Phase Plane and Lyapunov Stability Analysis	(8 hours)
5.1	Phase plots: Concepts- Singular points - Classification of singular points.	1
5.2	Construction of phase trajectories using Isocline method for linear and nonlinear systems	2
5.3	Definition of stability- asymptotic stability and instability	1
5.4	Lyapunov stability analysis: Lyapunov function- Lyapunov methods to stability of nonlinear systems	2
5.5	Lyapunov methods to LTI continuous time systems.	2

----- x -----

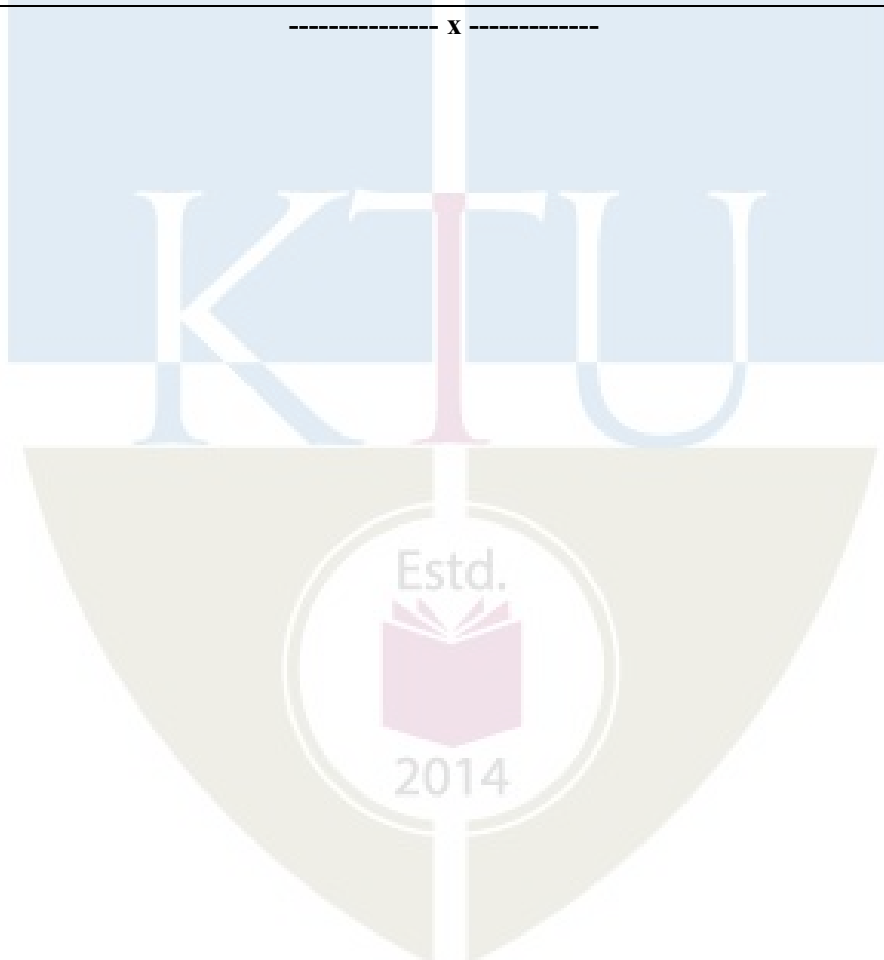

EET413	ELECTRIC DRIVES	CATEGORY	L	T	P	CREDIT
		PEC	2	1	0	3

Preamble: To impart knowledge about the DC and AC motor drives and its applications

Prerequisite: EET306 Power Electronics, EET202 DC Machines and Transformers and EET307 Synchronous and Induction Machines.

Course Outcomes: After the completion of the course the student will be able to

CO 1	Describe the transient and steady state aspects electric drives
CO 2	Apply the appropriate configuration of controlled rectifiers for the speed control of DC motors
CO 3	Analyse the operation of chopper-fed DC motor drive in various quadrants
CO 4	Illustrate the various speed control techniques of induction motors
CO 5	Examine the vector control of induction motor drives
CO 6	Distinguish different speed control methods of synchronous motor drives

Mapping of course outcomes with program outcomes

	PO 1	PO 2	PO 3	PO 4	PO 5	PO 6	PO 7	PO 8	PO 9	PO 10	PO 11	PO 12
CO 1	3	2	-	-	-	-	-	-	-	-	-	-
CO 2	3	2	-	2	-	-	-	-	-	-	-	1
CO 3	3	2	-	2	-	-	-	-	-	-	-	1
CO 4	3	2	-	2	-	-	-	-	-	-	-	1
CO 5	3	1	-	2	-	-	-	-	-	-	-	1
CO 6	3	2	-	2	-	-	-	-	-	-	-	1

Assessment Pattern

Bloom's Category	Continuous Assessment Tests		End Semester Examination
	1	2	
Remember (K1)	10	10	20
Understand (K2)	20	20	40
Apply (K3)	20	20	40
Analyse (K4)			
Evaluate (K5)			
Create (K6)			

Mark distribution

Total Marks	CIE	ESE	ESE Duration
150	50	100	3 hours

Continuous Internal Evaluation Pattern:

Attendance	: 10 marks
Continuous Assessment Test (2 numbers)	: 25 marks
Assignment/Quiz/Course project	: 15 marks

End Semester Examination Pattern: There will be two parts; Part A and Part B. Part A contain 10 questions with 2 questions from each module, having 3 marks for each question. Students should answer all questions. Part B contains 2 questions from each module of which student should answer any one. Each question can have maximum 2 sub-divisions and carry 14 marks.

Course Level Assessment Questions**Course Outcome 1 (CO1):**

1. Derive the condition for steady state stability (K3,K4, PO1, PO4).
2. Draw the speed torque characteristics of traction drive (K1, PO1).
3. Problems based on fundamental torque equations and equivalent values of drive parameters (K3, K4 , PO2, PO4).

Course Outcome 2 (CO2)

1. Numerical problems based on rectifier controlled separately excited dc motor. (K3, K4, PO2, PO4).
2. Describe the function of a three phase inverter driving a dc motor (K2, PO1).
3. Draw the circuit diagram of dual converter and explain the operation (K1, PO1).

Course Outcome 3(CO3):

1. Explain Motoring and braking operation of chopper controlled DC motor (K2,PO1).
2. Numerical problems based on chopper controlled separately excited dc motor. (K3, K4, PO2, PO4).
3. With the block diagram illustrate the closed loop control of SEDC motor (K2, PO4).

Course Outcome 4 (CO4):

1. List different speed control methods for three phase induction motors (K1, PO1)

2. Discuss sine triangle PWM control of three phase induction motor drive (K2, PO4).
3. Numerical problems based on speed control of induction motor drives (K3,K4, PO2, PO4).

Course Outcome 5 (CO5):

1. Draw the block diagram of direct vector control of induction motor drives (K2, PO1).
2. Figure out the differences of scalar and vector control methods of three phase induction motor (K3, PO1).
3. Draw the decoupled diagram and phasor diagram of three phase induction motor (K2, PO1).

Course Outcome 6 (CO6):

1. Explain v/f control of three phase synchronous motor drive (K2, PO1).
2. Enumerate different speed control methods of synchronous motor drives (K1, PO1).
3. With the diagram of load commutated CSI synchronous motor drive discuss the operation (K2, PO1).

Model Question Paper

PAGES: 3

QPCODE:

Reg. No: _____

Name: _____

**APJ ABDUL KALAM TECHNOLOGICAL UNIVERSITY
SEVENTH SEMESTER B. TECH DEGREE EXAMINATION
MONTH & YEAR**

Course Code: **EET413**Course Name: **ELECTRIC DRIVES****Max. Marks: 100****Duration: 3 Hours****PART A****Answer all Questions.****Each question carries 3 Marks**

- 1 Draw the block diagram of an electric drive.
- 2 List 3 classifications of load torque with one example for each.
- 3 For a single phase fully-controlled rectifier fed separately excited DC motor, the armature current is assumed to be continuous and ripple free ($i_a = I_a$). Draw the source current waveform for a firing angle of 45° .

- 4 Can a half-controlled rectifier fed separately excited DC drive operated in quadrant IV? Justify your answer.
- 5 Draw the circuit diagram of a two-quadrant (class C) chopper showing the two quadrants of operation.
- 6 With the help of the torque – speed characteristics of a DC series motor, explain why it is used for high-starting torque applications?
- 7 Constant torque loads are not suitable for AC voltage controller fed induction motor drive. Why?
- 8 Why V/f ratio is kept constant upto base speed and V constant above base speed in variable frequency control of an induction motor?
- 9 Differentiate between true synchronous mode and self-control mode of operation of a synchronous motor.
- 10 List any two advantages of vector control of 3-phase induction motors.

PART B

Answer any one full question from each module.

Each question carries 14 Marks

Module 1

- 11 a) What are the advantages of electric drives? (7)
 b) Explain the multi-quadrant operation of a motor driving a hoist load. (7)
- 12 a) Explain about steady state stability of equilibrium point in electric drive. (7)
 b) A drive has following parameters: - $J=10\text{kg-m}^2$, $T=100-0.1N$ and $T_l=0.05N$ where N is the speed in rpm. Initially the drive is operating in steady state. Now it is to be reversed. For this motor characteristics is changed to $T = -100-0.1N$. Calculate the time of reversal. (7)

Module 2

- 13 a) Explain the working of 3-phase fully-controlled separately excited DC drive with necessary waveforms. (7)
 b) A 220V, 1500rpm, 10A separately excited DC motor is fed from a single phase fully controlled rectifier with an ac source voltage of 230V, 50Hz. $R_a=2\Omega$. Conduction can be assumed to be continuous. Calculate the firing angles for rated motor torque and -1000rpm. (7)
- 14 a) Explain the discontinuous conduction mode of operation of a fully controlled rectifier fed separately excited DC motor with necessary waveforms. (7)
 b) Explain the working of a dual converter (circulating current type) fed separately excited DC motor. (7)

Module 3

- 15 a) Explain the operation of four quadrant chopper fed DC drives. (7)
 b) A chopper used to control the speed of a separately excited DC motor has supply voltage of 230V, $T_{on} = 15\text{ms}$, $T_{off} = 5\text{ms}$. Assuming continuous conduction of motor current, calculate the average load current when the motor speed is 3000rpm. Assume voltage constant $K_v = 0.5\text{V/rad/sec}$ and $R_a = 4\Omega$. (7)

- 16 a) Explain the chopper control of DC series motor. (7)
 b) Using a neat block diagram, explain the closed loop speed control for a separately excited DC motor. (7)

Module 4

- 17 a) Explain V/f control of 3-phase induction motor using necessary speed – torque characteristics. (7)
 b) A 440V, 3-phase, 50Hz, 6-pole, 945rpm, delta connected induction motor has following parameters referred to the stator: $R_s = 2\Omega$, $R_r' = 2\Omega$, $X_s = 3\Omega$, $X_r' = 4\Omega$. When driving a fan load at rated voltage it runs at rated speed. The motor speed is controlled by stator voltage control. Determine motor terminal voltage, current and torque at 800rpm. (7)
- 18 a) Explain the working of static rotor resistance control of 3-phase induction motor. Also derive the expression for the total rotor circuit resistance per phase. (7)
 b) Explain the static slip power recovery scheme using one uncontrolled bridge rectifier and one controlled bridge rectifier in the rotor circuit. (7)

Module 5

- 19 a) Describe the principle of operation of vector control. (7)
 b) Explain the variable frequency control of multiple synchronous motor. (7)
- 20 a) Explain Clerke and Park transformation with necessary equations. (5)
 b) Describe the working of a self-controlled synchronous motor drive employing load commutated thyristor inverter. (9)

Syllabus (36 hours)

Module 1 (6 hours)

Introduction to electric drives – block diagram – advantages of electric drives – dynamics of motor load system, fundamental torque equations, types of load – classification of load torque, four quadrant operation of drives, Equivalent values of drive parameters- effect of gearing - steady state stability.

Module 2 (7 hours)

Rectifier control of DC drives- separately excited DC motor drives using controlled rectifiers- single-phase fully controlled rectifier fed drives (discontinuous and continuous mode of operation), critical speed - single-phase semi converter fed drives (continuous mode of operation) - three-phase semi converter and fully controlled converter fed drives (continuous mode of operation) - dual converter control of DC motor - circulating current mode.

Module 3 (6 hours)

Chopper control of DC drives - two quadrant and four quadrant chopper drives - motoring and regenerative braking - chopper fed DC series motor drive - closed loop speed control for separately excited dc motor.

Module 4 (10 hours)

Three phase induction motor drives: Stator voltage control - Stator frequency control – v/f control - below and above base speed – Voltage Source Inverter (VSI) fed v/f control using sine-triangle PWM - static rotor resistance speed control employing chopper – static slip power recovery speed control scheme for speed control below synchronous speed.

Module 5 (7 hours)

Concept of space vector – Clarke and Park transformation – field orientation principle – Introduction to direct vector control of induction motor drives – decoupling of flux and torque components - space vector diagram and block diagram [Ref.1].

Synchronous motor drives – v/f control – open loop control – self-controlled mode – load commutated CSI fed synchronous motor.

Note: Simulation assignments can be given using modern simulation tools like MATLAB, PSIM, PSpice, LTspice etc. from all modules of 2, 3, 4 and 5.

Text Books

1.G. K. Dubey, “Fundamentals of Electric Drives”, Narosa publishers, second edition, 2001

Reference Books.

1. Bimal K. Bose, “Power Electronics and and Motor Drives”, Academic press, An Imprint of Elsevier, 2006.
2. Vedam Subrahmanyam, “Electric Drives Concepts and Applications”, MC Graw Hill Education, second edition, 2011, New Delhi.
3. Dr. P. S. Bimbhra, “Power Electronics”, Khanna publishers, fifth edition, 2012.
4. Ned Mohan, Tore M Undeland, William P Robbins, “Power electronics converters applications and design”, John Wiley and Sons Inc., 3rd edition
5. Muhammad H. Rashid, “Power Electronics, Devices, Circuits and Applications”, Pearson, 3rd edition, 2014
6. R Krishnan, “Electric Motor Drives: Modeling, Analysis, and Control”, Prentice Hall, 2001.

Course Contents and Lecture Schedule

No	Topic	No. of Lectures
1	Fundamentals of Electric drives (6 hours)	
1.1	Introduction to electric drives- block diagram – advantages of electric drives	1
1.2	Dynamics of motor load system, fundamental torque equations,	1
1.3	four quadrant operation of drives	1
1.4	Types of load – classification of load torque	1
1.5	Equivalent values of drive parameters- effect of gearing -	1
1.6	Steady state stability	1
2	Rectifier Control of DC drives (7 hours)	
2.1	Rectifier controlled DC drives- separately excited DC motor drives using controlled rectifiers- single-phase fully controlled rectifier fed drives discontinuous mode of operation,	2
2.2	continuous mode of operation - critical speed	1
2.3	single-phase semi converter fed drives (continuous mode of operation)	1
2.4	three-phase semi converter controlled converter fed drives (continuous mode of operation)	1
2.5	Three phase fully controlled converter fed drives (continuous mode of operation)	1
2.6	Dual converter control of DC motor - circulating current mode	1
3	Chopper control of DC drives (6 hours)	
3.1	Two quadrant chopper DC drives - motoring and regenerative braking	2
3.2	Four quadrant chopper DC drives	1
3.3	Chopper fed DC series motor drive	2
3.4	Closed loop speed control for separately excited dc motor.	1
4	Three phase induction motor drives (10 hours)	
4.1	Stator voltage control - Stator frequency control	1
4.2	v/f control - below and above base speed	2
4.3	Voltage Source Inverter (VSI) fed v/f control using sine-triangle PWM	2
4.4	Static rotor resistance speed control employing chopper	1
4.5	Static slip power recovery speed control scheme for speed control below synchronous speed.	1
4.6	Auto Sequential Commutated Current source Inverter (CSI) fed induction motor drives	1
4.7	Current regulated VSI using power semiconductor devices, operation and control scheme - comparison of CSI and VSI fed	2

	drives.	
5	Concept of space vector , Synchronous motor drives (7 hours)	
5.1	Concept of space vector – Clarke and Park transformation – field orientation principle – Introduction to direct vector control of induction motor drives – decoupling of flux and torque components - space vector diagram and block diagram.	4
5.2	Synchronous motor drives – v/f control – open loop control	1
5.3	Self-controlled mode – load commutated CSI fed synchronous motor.	2

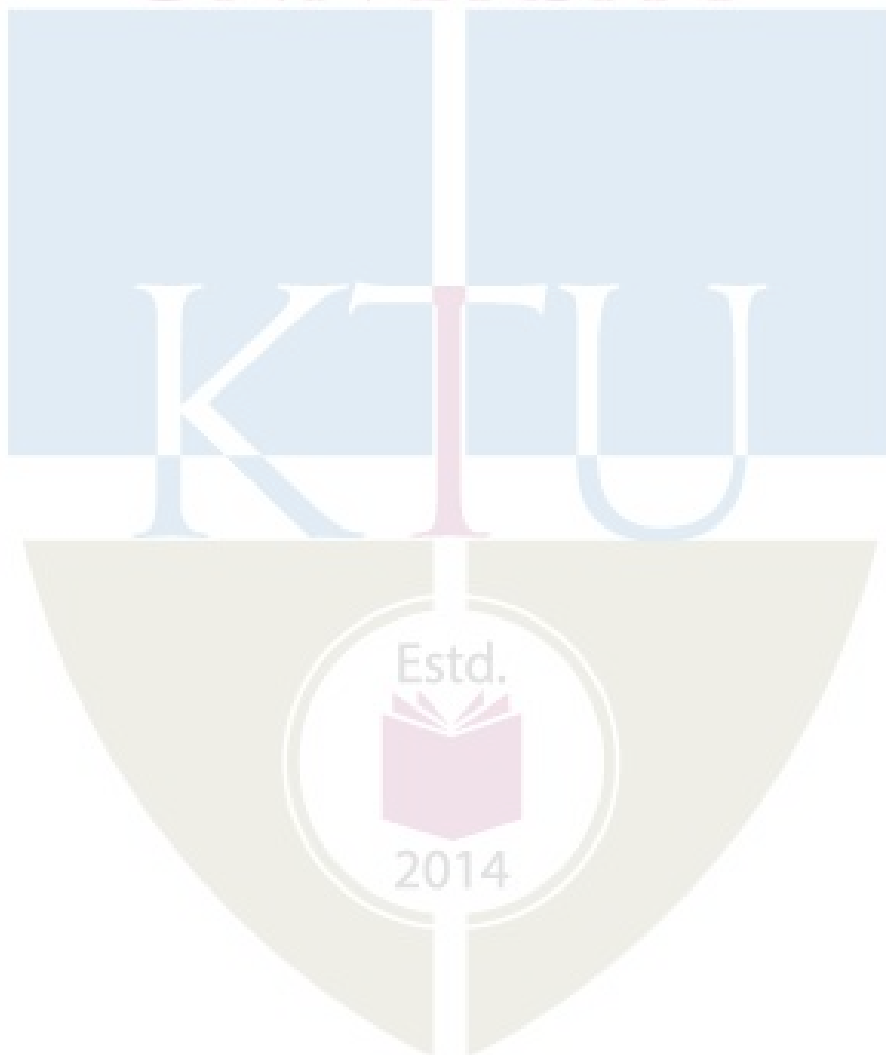

CODE	COURSE NAME	CATEGORY	L	T	P	CREDIT
EET423	DIGITAL CONTROL SYSTEMS	PEC	2	1	0	3

Preamble: This course aims to provide a strong foundation in discrete domain modelling, analysis and design of digital controllers to meet performance requirements.

Prerequisite: EET201 Circuits and Networks, EET305 Signals and Systems, and EET302 Linear Control Systems

Course Outcomes : After the completion of the course the student will be able to:

CO 1	Describe the various control blocks and components of digital control systems.
CO 2	Analyse sampled data systems in z-domain.
CO 3	Design a digital controller/ compensator in frequency domain.
CO 4	Design a digital controller/ compensator in time domain.
CO 5	Apply state variable concepts to design controller for linear discrete time system.

Mapping of course outcomes with program outcomes

	PO 1	PO 2	PO 3	PO 4	PO 5	PO 6	PO 7	PO 8	PO 9	PO 10	PO 11	PO 12
CO 1	3	3	3	-	-	-	-	-	-	-	-	2
CO 2	3	3	3	3	-	-	-	-	-	-	-	2
CO 3	3	3	3	3	2	-	-	-	-	-	-	3
CO 4	3	3	3	3	2	-	-	-	-	-	-	3
CO 5	3	3	3	3	-	-	-	-	-	-	-	3

Assessment Pattern:

Total Marks	CIE marks	ESE marks	ESE Duration
150	50	100	03 Hrs

Bloom's Category	Continuous Assessment Tests		End Semester Examination
	1	2	
Remember (K1)	10	10	10
Understand (K2)	15	15	30
Apply (K3)	25	25	50
Analyse (K4)			
Evaluate (K5)			
Create (K6)			

End Semester Examination Pattern : There will be two parts; Part A and Part B. **Part A** contains 10 questions with 2 questions from each module, having 3 marks for each question. Students should answer all questions.

Part B contains 2 questions from each module of which student should answer any one. Each question carries 14 marks and can have maximum 2 sub-divisions.

Course Level Assessment Questions:**Course Outcome 1 (CO1)**

1. Selection of sampling period and elements of discrete time systems (K2) (PO1, PO2).
2. Derivation of the transfer functions of discrete time systems (K3)(PO1, PO2, PO3, PO12).
3. Relations between continuous system poles and that in discrete domain (K2) (PO1, PO2).

Course Outcome 2 (CO2):

1. Derivation of pulse transfer function or response function of various system configurations (K3) (PO1, PO2, PO3, PO4, PO12).
2. Determination of time response of systems, error constant and steady state error (K2) (PO1, PO2).
3. Problems to analyse the response of systems (K3) (PO1, PO2, PO3, PO4, PO12).

Course Outcome 3(CO3):

1. Obtain the frequency response and design controller (K3) (PO1, PO2, PO3, PO4, PO5, PO12).
2. Design suitable compensator in frequency domain (K3) (PO1, PO2, PO3, PO4, PO5, PO12).
3. Problems related to compensator and controller design in frequency domain (K3) (PO1, PO2, PO3, PO4, PO5, PO12).

Course Outcome 4 (CO4):

1. Problems related to design controller from time response (K3) (PO1, PO2, PO3, PO4, PO5, PO12).
2. Design suitable compensator in time domain (K3) (PO1, PO2, PO3, PO4, PO5, PO12).
3. Problems related compensator and controller design in time domain (K3) (PO1, PO2, PO3, PO4, PO5, PO12).

Course Outcome 5 (CO5):

1. Problems related to modelling and analysis (stability, controllability and observability) of system in state space (K2) (PO1, PO2, PO3, PO4).
2. Design a state feedback controller and observer (K3) (PO1, PO2, PO3, PO4).
3. Problems to identify the response and solution of state equation (K2) (PO1, PO2, PO3, PO4).

Model Question Paper

PAGES: 2

QP CODE:

Reg.No: _____

Name: _____

**APJ ABDUL KALAM TECHNOLOGICAL UNIVERSITY
SEVENTH SEMESTER B.TECH DEGREE EXAMINATION
MONTH & YEAR**

Course Code: EET423

Course Name: DIGITAL CONTROL SYSTEMS

Max. Marks: 100

Duration: 3 Hours

PART A

Answer all Questions. Each question carries 3 Marks

- 1 Explain any four advantages of sampled data control systems.
- 2 Identify and justify a suitable sampling frequency for the continuous time system with transfer function $G(s) = \frac{100}{(s+1)(s+10)(s+100)}$

- 3 Obtain the pulse transfer function for the given system.

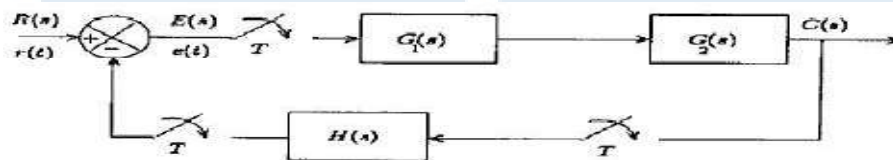

- 4 Distinguish between type and order of a system.
- 5 Explain the frequency domain specifications.
- 6 Realize the digital compensator with transfer function $D(z) = \frac{2.3798z - 1.9387}{z - 0.5589}$
- 7 Draw and explain the mapping between s- plane to z-plane for the constant frequency loci.
- 8 What is dead beat response?
- 9 Identify the discrete equivalent of the continuous time system $\dot{x} = Ax$ when the sampling period is T_s
- 10 Define controllability and observability.

PART B

Answer any one full question from each module. Each question carries 14 Marks

Module 1

- 11 a) Derive the transfer function of a FoH circuit. (6)
- b) Determine the pulse transfer function of the system with transfer function $H(s) = \frac{3}{s(s+2)^2}$ if the sampling period is 0.1s. (8)
- 12 a) Derive the transfer function of a ZoH circuit. (5)
- b) Realize the digital filter $D(z) = \frac{2z-0.6}{z+0.5}$ by the three methods of direct, standard and ladder programming. (9)

Module 2

- 13 Obtain the pulse transfer function for the unity feedback system with $G_1(s) = \frac{1}{s}$, $G_2(s) = \frac{1}{(s+2)}$ and assume $T=0.1s$ and hence determine the step response of the system.

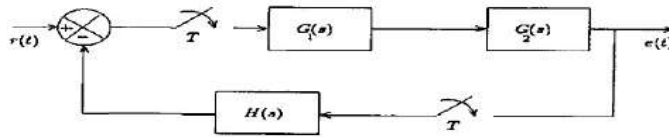

- (14)
14 a) Obtain the unit impulse response $C(n)$ of the following feedback DT system with

$$G(s) = \frac{1}{(s+3)}, H(s) = \frac{1}{s}$$

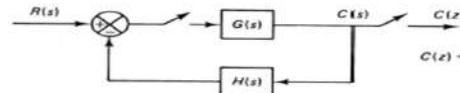

- Assume ideal sampling and $T=1$ ms. (9)
b) Explain the factors on which the steady state error constants depend on? (5)

Module 3

- 15 Design a suitable compensator for the unity feedback system with forward transfer function $G(z) = \frac{0.01758(z+0.8753)}{(z-1)(z-0.6703)}$, $T = 0.1s$, such that the phase margin of the system be atleast 45° at approximately 2 rad/sec and velocity error constant atleast $100s^{-1}$. (14)

- 16 Consider the unity feedback system with forward transfer function

$$G(z) = \frac{K(0.01873z + 0.01752)}{z^2 - 1.8187z + 0.8187}$$

Design a controller for the system such that the w -plane phase margin is 50° , gain margin is 10dB, and the static velocity error constant is 2 sec^{-1} . Assume a sampling period of 0.2sec.

(14)

Module 4

- 17 Design a suitable digital compensator for the unity feedback system with open loop transfer function $G(s) = \frac{1}{s(s+4)}$ to meet the following specifications. Velocity error constant $K_v \geq 40 \text{ sec}^{-1}$, Damping factor $\zeta = 0.5$, Natural frequency $\omega_n = 4 \text{ rad/sec}$.

Assume a sampling period of 0.1s (14)

- 18 Design a controller, by the method of Ragazzini, for the unity feedback system with open loop transfer function $G(z) = \frac{0.018201(z+0.905)}{(z-1.105)(z-0.6703)}$, $T = 0.1s$ to meet the following specifications. Damping factor $\zeta = 0.5$, Natural frequency $\omega_n = 2 \text{ rad/sec}$ and zero steady state error for unit step input. (14)

Module 5

- 19 Design a suitable controller for the system by selecting suitable poles. $x(k+1) = \begin{bmatrix} 0.9128 & -0.008826 & 0.1574 \\ 0.09194 & 1.114 & -0.1662 \\ 0.07429 & -0.08753 & 0.6855 \end{bmatrix} x(k) + \begin{bmatrix} 0.104 \\ -0.00411 \\ 0.08707 \end{bmatrix} u(k)$, $y(k) = [0 \ 1 \ 0]x(k)$ Formulate the control law that can perfectly track a step command. Since the output is directly available for measurement. design a reduced

order observer to realise the controller.

(14)

- 20 Compute the unit step response of the system represented by $x(k+1) = \begin{bmatrix} 0.9048 & 0 \\ 0.08611 & 0.8187 \end{bmatrix} x(k) + \begin{bmatrix} 0.09516 \\ 0.09516 \end{bmatrix} u(k)$, $y(k) = [1 \ 1]x(k)$ assume the initial state $x(0) = \begin{bmatrix} 1 \\ 2 \end{bmatrix}$.

(14)

Syllabus

Module 1

Basics of Digital Control (6 hours)

Basic digital control system- Mathematical modelling - sampling and reconstruction - Zero order and First order hold circuits - realisation of digital filters. Relation between transfer function and pulse transfer function - Mapping between s-domain and z-domain.

Module 2

Response Computation (7 hours)

Pulse transfer function of different configurations of systems- Modified z-transform- Time Response of discrete time system. Order and Type of a system Steady state error and Static error constants.

Module 3

Design of controller/Compensator in frequency domain (7 hours)

Bilinear transformation and sketching of frequency response - Digital P/PI/PID controller design based on frequency response - Digital compensator based on frequency response. Introduction to design and simulation using MATLAB (for demo/ assignment only and not to be included for examination).

Module 4

Design of controller/Compensator based on time response (7 hours)

Design of lag, lead and lag-lead compensator using root locus - Design of controllers and compensators by the method of Ragazzini- Dead beat response and deadbeat controller design.

Module 5

Modern control approach to digital control (10 hours)

Introduction to state space - state space modelling of discrete time SISO system - Computation of solution of state equation and state transition matrix. Controllability, observability and stabilizability of discrete time systems- Loss of controllability and observability due to sampling. Digital controller and observer design - state feedback – pole placement - full order observer - reduced order observer.

Text Book:

1. C. L. Philips, H. T. Nagle, Digital Control Systems, Prentice-Hall, Englewood Cliffs, New Jersey, 1995.
2. M. Gopal, Digital Control and State Variable Methods, Tata McGraw-Hill, 1997
3. Ogata K., Discrete-Time Control Systems, Pearson Education, Asia.

References:

1. Benjamin C. Kuo, Digital Control Systems, 2/e, Saunders College Publishing, Philadelphia, 1992.
2. Constantine H. Houppis and Gary B. Lamont, Digital Control Systems Theory, Hardware Software, McGraw Hill Book Company, 1985.
3. Isermann R., Digital Control Systems, Fundamentals, Deterministic Control, V. I, 2/e, Springer Verlag, 1989.
4. Liegh J. R., Applied Digital Control, Rinchart & Winston Inc., New Delhi.
5. Åström, Karl J., and Björn Wittenmark,. Computer-controlled systems: theory and design. Courier Corporation, 2013.

Course Contents and Lecture Schedule

No	Topic	No. of Lectures
1	Basics of Digital Control	(6 hours)
1.1	Basic digital control system- Examples - mathematical model - choice of sampling and reconstruction-ZOH and FOH	2
1.2	Realisation of digital filters.	2
1.3	Relation between s and z - Mapping between s-domain and z-domain	2
2	Response Computation	(7 hours)
2.1	Pulse transfer function- Different configurations for the design	2
2.2	Time Response of discrete time system.	2
2.3	Steady state performance and error constants.	3
3	Design of controller/Compensator in frequency domain	(7 hours)
3.1	Digital P/PD/PI controller design	2
3.2	Digital PID controller design	1
3.3	Design of lag and lead compensator,	2
3.4	Design of lag-lead compensator.	1
3.5	Demo with MATLAB	1
4	Design of controller/Compensator based on time response	(7 hours)
4.1	Design of lag and lead compensator.	2
4.2	Design of lag-lead compensator.	1
4.3	Design based on method of Ragazzini.	2
4.4	Dead beat response design and deadbeat controller design.	2
5	Modern control approach to digital control	(10 hours)
5.1	Introduction to state space-	1
5.2	Computation of solution of state equation and state transition matrix. (examination questions can be limited to second order systems)	2
5.3	Controllability, Observability, and stabilizability of systems	2
5.4	Loss of controllability and observability due to sampling.	1
5.5	State feedback controller based on pole placement.	2
5.6	Observer design based on pole placement.	2

CODE	COURSE NAME	CATEGORY	L	T	P	CREDIT
EET433	MODERN OPERATING SYSTEMS	PEC	2	1	0	3

Preamble: Understanding of concepts of OS, through process/threads, system call interface, inter process communication, deadlock, scheduling, address space, main memory, virtual memory and file systems.

Prerequisite: NIL

Course Outcomes: After the completion of the course the student will be able to:

CO 1	Describe the key concepts of modern operating systems
CO 2	Apply the concepts of scheduling, resource management and process synchronization for process management.
CO 3	Evaluate the implementation of various memory management techniques.
CO 4	Illustrate different file management and directory management methods.
CO 5	Evaluate Disc scheduling algorithms
CO 6	Explain RAID structures

Mapping of course outcomes with program outcomes

	PO 1	PO 2	PO 3	PO 4	PO 5	PO 6	PO 7	PO 8	PO 9	PO 10	PO 11	PO 12
CO 1	2											
CO 2	2	2										2
CO 3	2	2										2
CO 4	2											
CO 5	2	2										

Assessment Pattern

Bloom's Category	Continuous Assessment Tests		End Semester Examination
	1	2	
Remember (K1)	15	15	30
Understand (K2)	20	20	40
Apply (K3)	15	15	30
Analyse (K4)			
Evaluate (K5)	-	-	-
Create (K6)	-	-	-

Mark distribution

Total Marks	CIE	ESE	ESE Duration
150	50	100	3 hours

Continuous Internal Evaluation Pattern:

Attendance	: 10 marks
Continuous Assessment Test (2 numbers)	: 25 marks
Assignment/Quiz/Course project	: 15 marks

End Semester Examination Pattern: There will be two parts; Part A and Part B. Part A contain 10 questions with 2 questions from each module, having 3 marks for each question. Students should answer all questions. Part B contains 2 questions from each module of which student should answer any one. Each question can have a maximum 2 sub-divisions and carry 14 marks.

Course Level Assessment Questions**Course Outcome 1 (CO1):**

1. What is an operating system?(K1, PO1)
2. What are operating system services?(k2, PO1)
3. Explain time sharing operating system?(K1, PO1)
4. Explain OS structure?(K2, PO1, PO2)

Course Outcome 2 (CO2):

1. Define the process? (K1, PO1)
2. What is meant by the state of the process?(K1,PO2)
3. What are the types of schedulers?(K1, PO2)
4. Consider the following five processes, with the length of the CPU burst time given in milliseconds. Process Burst time P1 10 P2 29 P3 3 P4 7 P5 12 Consider the First come First serve (FCFS), Non Pre-emptive Shortest Job First (SJF), Round Robin(RR) (quantum=10ms) scheduling algorithms. Illustrate the scheduling using Gantt charts.(K3, PO1,PO2)
5. Define race condition.(K2, PO2)
6. What are the requirements that a solution to the critical section problem must satisfy?(K2, PO1, PO2)

Course Outcome 3 (CO3):

1. Define Swapping(K1,PO2)
2. What is Demand Paging?(K2,PO1,PO2)

3. Explain about the following page replacement algorithms a)FIFO b)OPR, c)LRU
4. Differentiate local and global page replacement algorithms. Differentiate local and global page replacement algorithm(K3, PO1,PO2)

Course Outcome 4 (CO4):

1. What is a File?(K1, PO1)
2. What are the various File Operations?(K1, PO1)
3. What are the different Accessing Methods of a File?(K2, PO2)
4. What are the Allocation Methods of a Disk Space?(K2, PO2)

Course Outcome 5 (CO5):

1. Explain different Disk scheduling algorithms SCAN,CSCAN.CLOOK(K3, PO1,PO2)
2. Explain disk structure in detail(K2, PO1)
3. What are goals for good disk scheduling algorithm(K1, PO1)
4. Define seek time, Rotational latency and disk bandwidth(K1, PO1)

Course Outcome 6 (CO6):

1. What is RAID Technology(K1, PO1)
2. What data is stored on the second hard drive with RAID 1?(K2,PO2)
3. Explain RAID level 10(K2, PO1, PO2)

Model Question Paper

**APJ ABDUL KALAM TECHNOLOGICAL UNIVERSITY SEVENTH SEMESTER
B.TECH DEGREE EXAMINATION,
MONTH & YEAR**

Course Code: EET433

Course Name:

**Max. Marks: 100
Hours**

Duration: 3

PART A (3 x 10 = 30 Marks)

Answer all Questions. Each question carries 3 Marks

1. Explain the concept of Multiprogramming and Multiprocessing
2. Enlist different kinds of computing environments
3. Compare and contrast user level threads & kernel level threads? Illustrate various multi-threading models.
4. What are the conditions for deadlock?

5. Differentiate between External fragmentation and Internal fragmentation
6. What is thrashing
7. Enlist five file attributes? What you mean by extended file attributes
8. Distinguish between sequential access file & direct access file. Give example on each
9. Define seek time, Rotational latency and disk bandwidth
10. Differentiate between viruses and worms , Give one example for each

PART B (14 x 5 = 70 Marks)

Answer any one full question from each module. Each question carries 14 Marks

Module 1

11. (a) Explain the role of OS as Extended Machine (7)
(b) Explain User Operating-System Interface in detail (7)
- OR**
12. (a) Differentiate between grid computing & Cloud computing. Give examples for each. (6)
(b) What are the functions of the process management module of the OS? What is PCB, Explain its structure (8)

Module 2

13. Consider the following five processes, with the length of the CPU burst time given in milliseconds. Process Burst time P1 10 P2 29 P3 3 P4 7 P5 12 Consider the First come First serve (FCFS), Non Preemptive Shortest Job First (SJF), Round Robin(RR) (quantum=10ms) scheduling algorithms. Illustrate the scheduling using Gantt chart. Also find average waiting time and turnaround time for each algorithm (14)
- OR**
14. (a) What is race condition? List the condition to be satisfied to ensure mutual exclusion in critical section (7)
(b) Explain semaphores. (7)

Module 3

15. (a) What is contiguous memory allocation? (7)
(b) Explain the different methods and strategies of contiguous memory allocation (7)

OR

16. (a) Explain paging scheme for memory management, discuss the paging hardware and Paging (5)
- (b) Explain about the following page replacement algorithms a) FIFO b) OPR, c) LRU (9)

Module 4

17. (a) What are the operations that can be performed on files (7)
- (b) Explain Indexed file allocation with proper illustration (7)

OR

18. (a) What is meant by directory structure (6)
- (b) What is free space management? Illustrate bit vector free space management technique (8)

Module 5

19. (a) What are goals for good disk scheduling algorithm (4)
- (b) Consider a disk with 300 tracks and the queue has random requests from different processes in the order: 60, 39, 23, 90, 170, 150, 38, 194, 295. Initially the arm is at 100. Find the Average Seek length using FIFO, SSTF, SCAN and C-SCAN algorithms (10)

OR

20. (a) Explain different RAID Level in details with proper illustration (8)
- (b) Explain programme threats and system threats with proper examples (6)

Syllabus

Module 1: Introduction-Definition- Operating System Structure- Operating System Operations, Process Management- Memory Management- Storage Management- Protection and Security- User and Operating-System Interface-System Calls- Types of System Calls Computing Environments- Open-Source Operating Systems.

Process Management- Process Concept- Operations on Processes-Threads Overview- Multithreading Models

Module 2 - CPU Scheduling- Basic Concepts- Scheduling Criteria- Scheduling Algorithms- First come first served scheduling - Shortest job first - Shortest remaining time next- Round robin scheduling - Priority scheduling.

Inter-process communication - race condition - critical sections - Mutual exclusion with busy waiting - sleep and wakeup - Semaphores, Mutexes

Introduction to Deadlocks
Module 3: Memory Management-Swapping- Contiguous Memory Allocation- Virtual memory - Paging - Page tables – TLBs - Page replacement algorithms - Optimal page replacement algorithm - - First-in first-out algorithm - Second chance page replacement algorithm - Clock algorithm - Least recently used algorithm - the working set page replacement algorithm -Belady’s anomaly, local versus global policies
Module 4: File Management- File-System Interface- File Concept- Access Methods - Directory and Disk Structure - File-System Mounting - File Sharing- Protection- File-System Implementation- File-System Structure- - Directory Implementation- Allocation Methods Free-Space Management - Efficiency and Performance
Module 5: Mass Storage Structure- Disk Scheduling- RAID Structure - - Protection and Security- Protection- Goals of Protection- Principles of Protection- Domain of Protection- Access Matrix Implementation of Access Matrix- Access Control- Revocation of Access Rights Security- The Security Problem -Program Threats- System and Network Threats

Text Book

1. Abraham Silberschatz, Greg Gagne, Peter B. Galvin Author, Operating System Concepts, 10th Edition “Title”, Publisher, 9thth edition, Wiley publishers

Reference Books

1. William Stallings “Operating Systems: Internals and Design Principles, 7th edition, prentice Hall
2. Andrew S. Tanenbaum; Modern Operating systems ,4th edition, Person publications

Course Content and Lecture Schedule

No	Topic	No. of Lectures
Module 1 (9 hrs)		
1.1	Introduction-Definition– Operating System Structure	1
1.2	Operating System Operations, Process Management and Memory Management	1
1.3	Storage Management- Protection and Security	1
1.4	User and Operating-System Interface	1
1.5	System Calls, Types of System Calls	1
1.6	Computing Environments- Open-Source Operating Systems	1
1.7	Process Management- Process Concept	1
1.8	Operations on Processes	1

1.9	Threads Overview- Multithreading Models	1
	Module 2 (8 hrs)	
2.1	CPU Scheduling- Basic Concepts- Scheduling Criteria	1
2.2	Scheduling Algorithms- First come first served scheduling- problems	1
2.3	Shortest job first - Shortest remaining time next- problems	1
2.4	Round robin scheduling - Priority scheduling.- problems	1
2.5	Inter-process communication - race condition - critical sections	1
2.6	critical sections and Mutual exclusion with busy waiting	1
2.7	Sleep and wakeup Semaphores, Mutexes	1
2.8	Deadlock- introduction only	1
	Module 3 (7 hrs)	
3.1	Memory Management-Swapping- Contiguous Memory Allocation	1
3.2	Virtual memory – Paging	1
3.3	Page tables – TLBs	1
3.4	Page replacement algorithms- Optimal page replacement algorithm - FIFO	1
3.5	Least recently used algorithm	1
3.6	Second chance page replacement algorithm - Clock algorithm	1
3.7	the working set page replacement algorithm -Beladys anomaly, local verses global policies	1
	Module 4 (7 hrs)	
4.1	File Management- File-System Interface- File Concept- Access Methods	1
4.2	Directory and Disk Structure	1
4.3	File-System Mounting - File Sharing- Protection- F	1
4.4	File-System Implementation- File-System Structure-	1
4.5	Directory Implementation-	1
4.6	Allocation Methods Free-Space Management	1
4.7	Efficiency and Performance	1
	Module 5 (5 hrs)	
5.1	Disk Scheduling-	1
5.2	RAID Structure	1
5.3	Protection- Goals of Protection- Principles of Protection- Domain of Protection	1
5.4	Access Matrix Implementation of Access Matrix- Access Control- Revocation of Access Rights Security-	1
5.5	The Security Problem -Program Threats- System and Network Threats	1

CODE	COURSE NAME	CATEGORY	L	T	P	CREDITS
EET443	DATA STRUCTURES	PEC	2	1	0	3

Preamble: This course aims at moulding the learner to understand the various data structures, their organization and operations. The course helps the learners to assess the applicability of different data structures and associated algorithms for solving real world problems efficiently. This course introduces abstract concepts for data organization and manipulation using data structures such as stacks, queues, linked lists, binary trees and graphs for designing their own data structures to solve practical application problems.

Prerequisite: EST 102 Programming in C

Course Outcomes: After the completion of the course the student will be able to:

CO 1	Analyze the time and space efficiency of the data structure(K3)
CO 2	Describe how arrays, records, linked structures, stacks and queues are used by algorithms (K1)
CO 3	Compare and contrast the benefits of dynamic and static data structures implementations(K3)
CO 4	Explain different memory management techniques and their significance (K3)
CO 5	Develop algorithms incorporating trees and graphs (K3)

Mapping of course outcomes with program outcomes

	PO 1	PO 2	PO 3	PO 4	PO 5	PO 6	PO 7	PO 8	PO 9	PO 10	PO 11	PO 12
CO 1	3	2										
CO 2	3	2										
CO 3	3	2										
CO 4	3	2										
CO 5	3	2										
CO 6	3	2										

Assessment Pattern

Bloom's Category	Continuous Assessment Tests		End Semester Examination
	1	2	
Remember (K1)	10	10	20
Understand (K2)	25	25	50
Apply (K3)	15	15	30
Analyse (K4)	-	-	-
Evaluate (K5)	-	-	-
Create (K6)	-	-	-

Mark distribution

Total Marks	CIE	ESE	ESE Duration
150	50	100	3 hours

Continuous Internal Evaluation Pattern:

Attendance	: 10 marks
Continuous Assessment Test (2 numbers)	: 25 marks
Assignment/Quiz/Course project	: 15 marks

End Semester Examination Pattern: There will be two parts; Part A and Part B. Part A contain 10 questions with 2 questions from each module, having 3 marks for each question. Students should answer all questions. Part B contains 2 questions from each module of which student should answer any one. Each question can have maximum 2 sub-divisions and carry 14 marks.

Course Level Assessment Questions**Course Outcome 1 (CO1):**

1. Derive the big O notation for $f(n) = n^2 + 2n + 5$ (K2,PO1)
2. What do you understand by complexity of an algorithm? Write worst case and best case
3. Find complexity of linear search.(K2,PO1)
4. Write an algorithm for matrix multiplication and calculate its time complexity. (K3,PO2)

Course Outcome 2 (CO2)

1. Write an algorithm/pseudo code to add a new element in a particular position of an array(K3,PO2)
2. Explain about the use and representation of header node in linked list (K1,PO1)
3. How a linked list can be used to represent the polynomial $5x^4y^6 + 24x^3y^4 - 17x^2y^3 + 15xy^2 + 45$.(K3,P02)
4. What is a circular queue? How it is different from normal queue? (K1,PO1)

Course Outcome 3(CO3):

1. Compare and contrast singly linked list and doubly linked list ((K2,PO1)
2. Write a program that implement stack (its operations) using i) Arrays ii) Linked list(Pointers) and compare performance(K3,PO2)
3. Compare array and linked list implementation of a general list.(K2,P02)
4. What are the disadvantages of representing a linear queue using array? How are they overcome (K1,PO1)

Course Outcome 4 (CO4):

1. Free memory blocks of size 60K, 25K, 12K, 20K, 35K, 45K and 40K are available in this order. Show the memory allocation for a sequence of job requests of size 22K, 10K, 42K, and 31K (in this order) in First Fit, Best Fit and Worst Fit allocation strategies (K3,PO2)
2. Explain how memory de-allocation is done in memory management (K1,PO1)
3. Compare various memory management techniques (K2,PO1)

Course Outcome 5 (CO5):

1. List the properties of a binary search tree. (K1,P01)
2. Create a Binary search Tree with node representing the following sequence 14, 15, 4, 18, 9, 16, 20, 17, 3, 7, 5, 2 and perform inorder, preorder and postorder traversals on the above tree and print the output. (K3,P02)
3. Develop an algorithm to add an element into a binary search tree (K3,P02)
4. Give any two representations of graph. Give algorithm for DFS. Demonstrate DFS using suitable example. (K2,P01)

Model Question Paper

QP CODE:

PAGES : 3

Reg No: _____

Name: _____

**APJ ABDUL KALAM TECHNOLOGICAL UNIVERSITY SEVENTH SEMESTER
B.TECH
DEGREE EXAMINATION, MONTH & YEAR**

Course Code: EET443

Course Name: DATA STRUCTURES

**Max.Marks:100
Hours**

Duration: 3

PART A

Answer all Questions. Each question carries 3 Marks

1. Compare Structured Approach and Object Oriented Approach of Programming.
2. Calculate the frequency count of the statement $x = x+1$; in the following code segment

```
for (i = 0; i < n; i++)
  for (j = 0; j < n; j*=2)
    x = x + 1;
```
3. Write an Algorithm to reverse a string using Stack.
4. Explain the disadvantages of representing a Linear Queue using Array.
5. Write any three Applications of Linked List.
6. Explain DEQUEUE
7. Write a non recursive algorithm/ Pseudocode for pre-order traversal in a binary tree.

8. What is a binary search tree (BST)? Give an example of a BST with five nodes.
9. Give two different types of representation for graphs.
10. Compare Prim's and Kruskal's Algorithm

PART B

- 11.a) Explain space complexity and time complexity of an Algorithm. Write an Algorithm/pseudo code for linear search and mention the best case and worst case time complexity of Linear Search algorithm?
(10)
 - b) Explain Modular Programming with Suitable Example (4)
- OR
- 12.a) Explain System Lifecycle in detail. (10)
 - b) Explain an algorithm? How is its complexity analysed? (4)
- 13.a) Write algorithms to insert and delete elements from a double ended Queue. Demonstrate with examples (10)
 - b) Compare and Contrast a Circular Queue with a normal Queue (4)
- OR
- 14.a) Write an Algorithm to evaluate Postfix operation. (8)
 - b) Convert the following infix expression into prefix expression
(A-B/C) * (D*E-F) .Show the stack contents for each step. (6)
- 15.a) Write algorithms to perform the following operations on a doubly linked list.
 - (i) Insert a node with data 'y' after a node whose data is 'x'.
 - (ii) Delete a node whose data is 's' .
 - (iii) Insert a node with data 'a' as the 1st node of the list. (10)
 - b) Write an algorithm to count the number of occurrences of a character in a linked list (each node contains only one character). (4)
- OR
- 16.a) Assume that a Stack is represented using Linked List. Write Algorithms for the following operations.
 - a) PUSH
 - b) POP (10)
 - b) Compare a Circular Linked List and a Doubly Linked List. (4)

17. a) Explain how memory de-allocation is done in memory management. (8)
 b) Discuss the advantages and Disadvantages of First-fit, Best-fit and Worst-fit Allocation schemes. (6)

OR

- 18.a) Write an algorithm/Pseudocode to perform the following operations on Binary Search tree.
 a) Insert an element k
 b) Search for an element k (10)
 b) Write an iterative algorithm for in-order traversal of a Binary Tree (4)
19. a) Explain the various ways in which a graph can be represented bringing out the advantages and disadvantages of each representation (10)
 b) Write an algorithm to perform bubble sort on a collection of 'n' numbers. (4)

OR

- 20.a) Give algorithms for DFS and BFS of a graph and explain with examples. (8)
 b) How graphs can be represented in a Computer? (6)

Syllabus

Module 1

Basic Concepts of Data Structures

Introduction to programming methodologies – structured approach, object oriented approach, stepwise refinement techniques, Algorithms, Performance Analysis, Space Complexity, Time Complexity, Asymptotic Notation, Complexity Calculation of Simple Algorithms

Module 2

Arrays

Introduction to data structures: Stacks, Queues-Circular Queues, Priority Queues, Double Ended Queues, Evaluation of Expressions, Applications of stacks and queues

Module 3

Linked List

Singly Linked List-Operations on Linked List. Doubly Linked List, Circular Linked List, Stacks and Queues using Linked List, Polynomial representation using Linked List

Module 4*Memory Management and Trees*

Memory Management - Memory allocation and de-allocation-First-fit, Best-fit and Worst-fit allocation schemes

Trees, Binary Trees-Tree Operations, Binary Tree Representation, Tree Traversals, Binary Search Trees- Binary Search Tree Operations

Module 5*Graphs*

Graphs : Definitions, Representation of Graphs, Topological Sort, Depth First Search and Breadth First Search on Graphs, Shortest-path algorithms, Minimum spanning tree, Prim's and Kruskal's algorithms, Applications of graphs

Text Book

1. Fundamentals of Data structures in C, 2nd Edition, E.Horowitz, S.Sahni and Susan Anderson-Freed, University Press (India),2008.

Reference Books

1. Classic Data Structures, Samanta D., Prentice Hall India, 2/e,,2009.
2. Data Structures: A Pseudocode Approach with C, 2/e, Richard F. Gilberg, Behrouz A. Forouzan, Cengage Learning 2005.
3. Data Structures and Algorithms, Aho A. V., J. E. Hopcroft and J. D. Ullman Pearson Publication. 2nd Edition
5. Introduction to Data Structures with Applications, Tremblay J. P. and P. G. Sorenson,Tata McGraw Hill 1995
4. Advanced Data Structures, Peter Brass ,Cambridge University Press,2008
5. Theory and Problems of Data Structures, Lipschuts S., Schaum's Series 1996
6. 8A Structured Approach to Programming, . Hugges J. K. and J. I. Michtm, PHI. 1987

Course Contents and Lecture Schedule:

No	Topic	No. of Lectures
1	Introduction	5
1.1	Introduction to programming methodologies – structured approach, object oriented approach, stepwise refinement techniques\	1
1.2	Algorithms , Performance Analysis	1
1.3	Space Complexity, Time Complexity	1
1.4	Asymptotic Notation (Big O Notation)	1

1.5	Complexity Calculation of Simple Algorithms	1
2	Arrays	7
2.1	Stacks	1
2.2	Queues, Circular Queues	1
2.3	Priority Queues	1
2.4	Double Ended Queues	1
2.5	Conversion and Evaluation of Expressions	1
2.6	Applications of stacks and queues	2
3	Linked List	8
3.1	Singly Linked List	1
3.2	Doubly Linked List	1
3.3	Circular Linked List	1
3.4	Stacks using Linked List	1
3.5	Queues using Linked List	1
3.6	Polynomial representation using Linked List	2
4	Memory Management and Trees	8
4.1	Memory allocation and de-allocation	1
4.2	First-fit, Best-fit and Worst-fit allocation schemes	2
4.3	Binary Trees- Tree Operations	1
4.4	Binary Tree Representation, Tree Traversals	2
4.5	Binary Search Trees- Binary Search Tree Operations	2
5	Graphs	7
5.1	Graphs Definitions, Representation of Graphs	1
5.2	Topological sort, Depth First Search and Breadth First Search on Graphs,	2

5.3	Shortest-path algorithms,	1
5.4	Minimum spanning tree	1
5.5	Prim's and Kruskal's algorithms, Applications of graphs	2

APJ ABDUL KALAM
TECHNOLOGICAL
UNIVERSITY

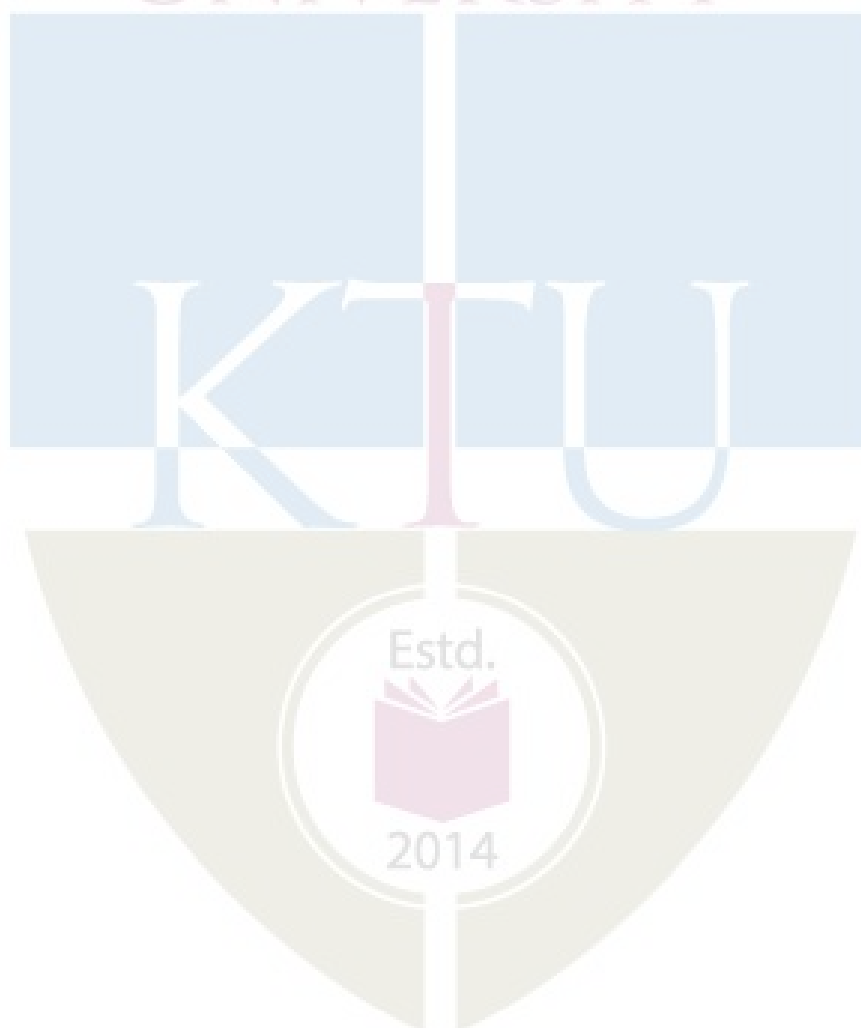

CODE	COURSE NAME	CATEGORY	L	T	P	CREDIT
EET453	DIGITAL SIGNAL PROCESSING	PEC	2	1	0	3

Preamble: This course introduces the discrete Fourier transform (DFT) and its computation using direct method and fast Fourier transform (FFT). Techniques for designing infinite impulse response (IIR) and finite impulse response (FIR) filters from given specifications are also introduced. Various structures for realization of IIR and FIR filters are discussed. Detailed analysis of finite word-length effects in fixed point DSP systems is included. Architecture of a digital signal processor is also discussed.

Prerequisite : EET305 - Signals and Systems

Course Outcomes: After the completion of the course the student will be able to

CO 1	Compute Discrete Fourier transform and Fast Fourier transform .
CO 2	Discuss the various structures for realization of IIR and FIR discrete-time systems.
CO 3	Design IIR (Butterworth and Chebyshev) digital filters using impulse invariant and bilinear transformation methods.
CO 4	Design FIR filters using frequency sampling method and window function method.
CO 5	Compare fixed point and floating point arithmetic used in digital signal processors and discuss the finite word length effects.
CO 6	Explain the architecture of digital signal processors and the applications of DSP.

Mapping of course outcomes with program outcomes

	PO1	PO2	PO3	PO4	PO5	PO6	PO7	PO8	PO9	PO10	PO11	PO12
CO 1	3	2	-	2	2	-	-	-	-	-	-	2
CO 2	3	2	-	2	2	-	-	-	-	-	-	2
CO 3	3	2	-	2	2	-	-	-	-	-	-	2
CO 4	3	2	-	2	2	-	-	-	-	-	-	2
CO 5	3	2	-	-	2	-	-	-	-	-	-	2
CO 6	3	-	2	-	2	2	-	-	-	-	-	3

Assessment Pattern

Bloom's Category	Continuous Assessment Tests		End Semester Examination
	1	2	
Remember (K1)	10	10	10
Understand (K2)	10	10	30
Apply (K3)	30	30	60
Analyse (K4)			
Evaluate (K5)			
Create (K6)			

Mark distribution

Total Marks	CIE	ESE	ESE Duration
150	50	100	3 hours

Continuous Internal Evaluation Pattern:

Attendance	: 10 marks
Continuous Assessment Test (2 numbers)	: 25 marks
Assignment/Quiz/Course project	: 15 marks

End Semester Examination Pattern: There will be two parts; Part A and Part B. Part A contain 10 questions with 2 questions from each module, having 3 marks for each question. Students should answer all questions. Part B contains 2 questions from each module of which student should answer any one. Each question can have maximum 2 sub-divisions and carry 14 marks.

Course Level Assessment Questions**Course Outcome 1 (CO1)**

1. State and prove various properties of DFT - (K1, PO1,PO2,PO12)
2. Determine the linear convolution using DFT – (K2,PO1,PO2,PO4,PO5,PO12)
3. Determine the linear convolution using overlap-add and overlap-save method – (K3,PO1,PO2,PO4,PO5)
4. Compute DFT using DIT FFT and DIF FFT – (K2,PO1,PO2,PO4,PO5)

Course Outcome 2 (CO2)

1. Determine the structures for direct form, cascade, parallel, transposed and lattice-ladder realisations of IIR systems –(K2,PO1,PO2,PO4,PO5,PO12)
2. Determine the structures for direct form, cascade, lattice ,and linear phase realizations of FIR systems – (K2,PO1,PO2,PO4,PO5)

Course Outcome 3(CO3)

1. Design IIR digital LP/HP/BP/BS filter using Butterworth and Chebyshev methods – (K3,PO1,PO2,PO4,PO5)
2. Transform $H(s)$ to $H(z)$ using impulse invariant technique and bilinear transformation – (K2,PO1,PO2,PO4,PO5,PO12)

Course Outcome 4 (CO4)

1. Design FIR digital LP/HP/BP/BS filter using frequency sampling method – (K3,PO1,PO2,PO4,PO5,PO12)
2. Design FIR digital LP/HP/BP/BS filter using window function – (K3,PO1,PO2,PO4,PO5)

Course Outcome 5 (CO5)

1. Differentiate between fixed-point arithmetic and floating point arithmetic - (K2,PO1,PO2,PO12)
2. Explain various finite word length effects in fixed point DSP processors.- (K2,PO1,PO2)
3. Problems to determine steady state output noise power and round-off noise power – (K3,PO1,PO2)
4. Explain limit cycle oscillations and methods for its elimination - (K2,PO1,PO2)

Course Outcome 6 (CO6)

1. Explain Harvard architecture –(K1,PO1,PO5,PO12)
2. Describe the architecture of a fixed-point DSP processor – (K1,PO1,PO5)
3. List various applications of digital signal processor – (K3,PO1,PO3,PO6)

Model Question Paper

PAGES: 3

QPCODE:

Reg. No: _____

Name: _____

**APJ ABDUL KALAM TECHNOLOGICAL UNIVERSITY
SEVENTH SEMESTER B. TECH DEGREE EXAMINATION
MONTH & YEAR**

Course Code: **EET453**Course Name: **DIGITAL SIGNAL PROCESSING****Max. Marks: 100****Duration: 3 Hours**

Estd.
PART A

Answer all Questions.

Each question carries 3 Marks

- 1 List any 3 properties of DFT.
The first 5 points of the 8-point DFT of a real valued sequence are
- 2 $X(k) = \{0.25, 0.125 - j0.3, 0, 0.125 - j0.05, 0\}$. Determine the remaining 3 points.
Obtain direct form 1 realization for a digital IIR system described by the
- 3 system function, $H(z) = \frac{z+0.2}{z^2+0.5z+1}$.
- 4 Obtain realization with minimum number of multipliers for the system function $H(z) = \frac{1}{2} + z^{-1} + \frac{1}{2}z^{-2}$.

- 5 Explain warping effect in bilinear transformation.
- 6 Determine the order of a Chebyshev analog lowpass filter with a maximum passband attenuation of 2.5dB at $\Omega_p = 20$ rad/sec and the stopband attenuation of 30dB at $\Omega_s = 50$ rad/sec.
- 7 What are the desirable characteristics of a window function used for truncating the infinite impulse response?
- 8 Represent the numbers i) +4.5 and ii) -4.5 in IEEE 754 single-precision floating point format.
- 9 List any 3 finite-word length effects in a fixed point digital signal processor.
- 10 Draw the block diagram of a basic Harvard architecture in digital signal processor.

PART B

Answer any one full question from each module.

Each question carries 14 Marks

Module 1

- 11 a) Find the 4-point DFT of the sequence, $x(n) = \{1, -1, 1, -1\}$. Also, using time shift property, find the DFT of the sequence, $y(n) = x((n-2))_4$. (7)
- b) Two finite duration sequences are $h(n) = \{1, 0, 1\}$ (7) and $x(n) = \{-1, 2, -1, 0, 1, 3, -2, 1, -3, -2, -1, 0, -2\}$. Use overlap-save method, to find $y(n) = x(n) * h(n)$.

OR

- 12 Compute IDFT of the sequence (14)
 $X(k) = \{7, -0.707 - j0.707, -j, 0.707 - j0.707, 1, 0.707 + j0.707, j, -0.707 + j0.707\}$ using DIT FFT.

Module 2

- 13 a) Realize the system function in cascade form $H(z) = \frac{1 + \frac{1}{3}z^{-1}}{1 - \frac{3}{4}z^{-1} + \frac{1}{8}z^{-2}}$. (6)
- b) Determine the direct form 2 and transposed direct form structure for the given system $y(n) = \frac{1}{2}y(n-1) - \frac{1}{4}y(n-2) + x(n) + x(n-1)$. (8)

OR

- 14 a) Obtain the direct form realization of linear phase FIR system given by (7)
 $H(z) = 1 + \frac{3}{4}z^{-1} + \frac{17}{8}z^{-2} + \frac{3}{4}z^{-3} + z^{-4}$
- b) Determine the coefficients k_m of the lattice filter corresponding to FIR filter (7) described by the system function $H(z) = 1 + 2z^{-1} + \frac{1}{3}z^{-2}$. Also, draw the corresponding second order lattice structure

Module 3

- 15 a) Find $H(z)$ using impulse invariant transformation. (7)

$$H(s) = \frac{1}{s^2 + \sqrt{2}s + 1}; \quad T = 1 \text{ sec.}$$

- b) A Butterworth lowpass filter has to meet the following specifications. (7)

i) Passband gain = -3dB at $f_p = 500\text{Hz}$

ii) Stopband attenuation greater than or equal to 40dB at $f_s = 1000\text{Hz}$

Determine the order of the Butterworth filter to meet the above specifications. Also, find the cut off frequency.

OR

- 16 Design a Chebyshev digital lowpass filter with a maximum passband attenuation of 2dB at 100Hz and minimum stopband attenuation of 20dB at 500Hz. Sampling rate is 4000 samples/sec. Use bilinear transformation. (14)

Module 4

- 17 a) Design a linear phase lowpass FIR filter with $N = 7$ and a cut-off frequency 0.3π radian using the frequency sampling method. (7)

- b) A linear phase FIR filter has frequency response $H(\omega) = \cos \frac{\omega}{2} + \frac{1}{2} \cos \frac{3\omega}{2}$ (7)

Determine the impulse response $h(n)$.

OR

- 18 A band stop filter is to be designed with the following desired frequency response (14)

$$\text{response } H_d(e^{j\omega}) = \begin{cases} e^{-j\omega\alpha} & -\omega_{c1} \leq \omega \leq \omega_{c1} \quad \omega_{c2} \leq |\omega| \leq \pi \\ 0 & \text{otherwise} \end{cases}$$

Design with $N = 7$, $\omega_{c1} = \pi/4$ rad/sec, $\omega_{c2} = 3\pi/4$ rad/sec using rectangular window.

Module 5

- 19 a) Compare between fixed point and floating point digital signal processors. (6)

- b) The output of an ADC is applied to a digital filter with system function (8)

$$H(z) = \frac{0.5z}{(z-0.5)}. \text{ Find the output noise power from digital filter when}$$

input signal is quantized to have 8 bits.

OR

- 20 a) Draw and explain the architecture of any fixed-point DSP processor. (8)

- b) Explain the techniques used to prevent overflow in fixed-point DSP operations. (6)

Module 1 - DISCRETE-FOURIER TRANSFORM

Review of signals and systems - Frequency domain sampling - Discrete Fourier transform (DFT) – inverse DFT (IDFT) - properties of DFT – linearity, periodicity, symmetry, time reversal, circular time shift, circular frequency shift, circular convolution, complex conjugate property – Filtering of long data sequences – over-lap save method, over-lap add method – Fast Fourier transform (FFT) – advantages over direct computation of DFT - radix -2 decimation-in-time FFT (DITFFT) algorithm, Radix-2 decimation-in-frequency FFT (DIFFFT) algorithm.

Module 2 - REALIZATION OF IIR AND FIR SYSTEMS

Introduction to FIR and IIR systems - Realization of IIR systems – direct form 1, direct form 2, cascade form, parallel form, lattice structure for all-pole system, lattice-ladder structure – conversion of lattice to direct form and vice-versa - signal flow graphs and transposed structures – Realization of FIR systems – direct form, cascade form, lattice structure, linear phase realization.

Module 3 - IIR FILTER DESIGN

Conversion of analog transfer function to digital transfer function – impulse invariant transformation and bilinear transformation – warping effect

Design of IIR filters – low-pass, high-pass, band-pass, band-stop filters – Butterworth and Chebyshev filter – frequency transformation in analog domain - design of LP, HP, BP, BS IIR digital filters using impulse invariance and bilinear transformation.

Module 4 - FIR FILTER DESIGN AND REPRESENTATION OF NUMBERS

Impulse response of ideal low pass filter – linear phase FIR filter – frequency response of linear phase FIR filter – Design of FIR filter using window functions (LP, HP, BP, BS filters) – Rectangular, Bartlett, Hanning, Hamming and Blackmann only – FIR filter design based on frequency sampling approach (LP, HP, BP, BS filters)

Representation of numbers – fixed point representation – sign-magnitude, one's complement, two's complement – floating point representation – IEEE 754 32-bit single precision floating point representation

Module 5 - FINITE WORD LENGTH EFFECTS AND DIGITAL SIGNAL PROCESSORS

Finite word length effects in digital Filters – input quantization – quantisation noise power – steady-state output noise power – coefficient quantisation – overflow – techniques to prevent overflow - product quantization error – rounding and truncation – round-off noise power – limit cycle oscillations – zero input limit cycle oscillations – overflow limit cycle oscillations – signal scaling.

Digital signal processor architecture based on Harvard architecture (block diagram) – Harvard architecture, pipelining, dedicated hardware multiplier/accumulator, special instructions dedicated to DSP, replication, on-chip memory cache, extended parallelism

(Reference [2]) - comparison of fixed-point and floating-point processor – applications of DSP

Text Books

1. John G. Proakis & Dimitris G. Manolakis, “Digital Signal Processing Principles, Algorithms & Applications”, Pearson

Reference Books

1. Emmanuel Ifeachor & Barrie W. Jervis, “Digital Signal Processing”, Pearson, 13th edition, 2013
2. P. Ramesh Babu, “Digital Signal Processing”, Scitech Publications (India) Pvt Ltd, 2nd edition, 2003
3. Li Tan, “Digital Signal Processing, Fundamentals & Applications”, Academic Press, 1st edition, 2008
4. D. Ganesh Rao & Vineeta P. Gejji, “Digital Signal Processing, A Simplified Approach”, Sanguine Technical Publishers, 2nd edition, 2008

Course Contents and Lecture Schedule

Sl. No	Topic	No. of Lectures
1	DISCRETE-FOURIER TRANSFORM (7 hours)	
1.1	Review of signals, systems and discrete-time Fourier transform (DTFT), Frequency domain sampling, discrete-Fourier transform (DFT), twiddle factor, inverse DFT, properties of DFT - linearity, periodicity, symmetry, time reversal, circular time shift, circular frequency shift, circular convolution, complex conjugate property	3 hours
1.2	Linear filtering using DFT, linear filtering of long data sequences, overlap-save method, overlap-add method	1 hour
1.3	Fast Fourier transform (FFT) – comparison with direct computation of DFT - radix -2 decimation-in-time FFT (DITFFT) algorithm – bit reversal - Radix-2 decimation-in-frequency FFT (DIFFFT) algorithm	3 hours
2	REALIZATION OF IIR AND FIR SYSTEMS (7 hours)	
2.1	Introduction to FIR and IIR systems - comparison - Realization of IIR systems – direct form 1, direct form 2, cascade form, parallel form	3 hours
2.2	Lattice structure for all-pole system - lattice-ladder structure – conversion of lattice to direct form and vice-versa signal flow graphs and transposed structures	2 hours
2.3	Realization of FIR systems – direct form, cascade form, lattice structure, linear phase realization.	2 hours
3	IIR FILTER DESIGN (7 hours)	
3.1	Conversion of analog transfer function to digital transfer function – impulse invariant transformation and bilinear transformation – warping effect	2 hours
3.2	Design of IIR filters – characteristics of ideal and practical low-pass, high-pass, band-pass, band-stop filters – design of Butterworth filter –	3 hours

	normalised analog filter - frequency transformation in analog domain - design of LP, HP, BP, BS IIR digital filters using impulse invariance and bilinear transformation.	
3.3	Design of Chebyshev filter – design of LP, HP, BP, BS IIR digital filters using impulse invariance and bilinear transformation	2 hours
4	FIR FILTER DESIGN AND REPRESENTATION OF NUMBERS (7 hours)	
4.1	Impulse response of ideal low pass filter – linear phase FIR filter – frequency response of linear phase FIR filter – Design of FIR filter using window function (LP, HP, BP, BS filters) – Rectangular, Bartlett, Hanning, Hamming and Blackmann only	3 hours
4.2	FIR filter design based on frequency sampling approach (LP, HP, BP, BS filters)	2 hours
4.3	Representation of numbers – fixed point representation – sign-magnitude, one’s complement, two’s complement – floating point representation – IEEE 754 32-bit single precision floating point representation	2 hours
5	FINITE WORD LENGTH EFFECTS AND DIGITAL SIGNAL PROCESSORS (7 hours)	
5.1	Finite word length effects in digital Filters – input quantization – quantisation noise power – steady-state output noise power	2 hours
5.2	Coefficient quantisation – overflow – techniques to prevent overflow - product quantization error – rounding and truncation – round-off noise power	1 hour
5.3	Limit cycle oscillations – zero input limit cycle oscillations – overflow limit cycle oscillations – signal scaling.	1 hour
5.4	Digital signal processor architecture based on Harvard architecture (block diagram) – Harvard architecture, pipelining, dedicated hardware multiplier/accumulator, special instructions dedicated to DSP, replication, on-chip memory cache, extended parallelism (Reference [1])	2 hours
5.5	Comparison of fixed-point and floating-point processor – applications of digital signal processor	1 hour

Note: Preferable list of computer based assignments

Assignments using signal processing tool of MATLAB/SCILAB etc	
1	Determine 4-point/8-point DFT/IDFT of any sequence by direct computation
2	Compute 4-point/8-point DFT/IDFT using DIT FFT and DIF FFT algorithms.
3	Find the linear convolution and circular convolution of two sequences.
4	Find the linear convolution using overlap-add and overlap-save methods.
5	Determine 2 stage/3 stage lattice ladder coefficients if the system function of IIR direct form is given.
6	Obtain coefficients of IIR direct form from lattice ladder form.
7	Transform an analog filter into digital filter using impulse invariant technique/bilinear transformation.
8	Calculate the order and cut-off frequency of a low pass Butterworth filter
9	Obtain the frequency response and filter coefficients of a LP/HP/BP/BS IIR

	Butterworth filter	ELECTRICAL AND ELECTRONICS
10	Obtain the frequency response and filter coefficients of a LP/HP/BP/BS IIR Chebyshev filter	
11	Compute LP/HP/BP/BS FIR filter coefficients using rectangular/Bartlett/Hamming/Hanning/Blackmann window	

APJ ABDUL KALAM
TECHNOLOGICAL
UNIVERSITY

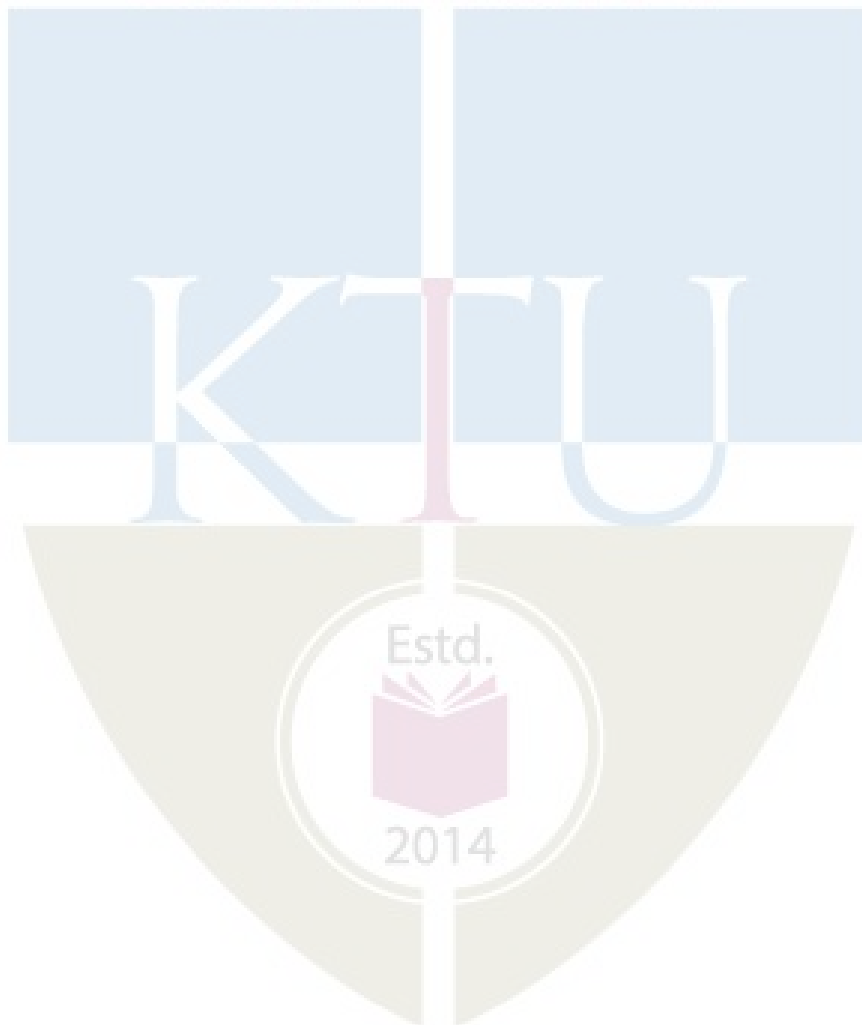

CODE	COURSE NAME	CATEGORY	L	T	P	CREDIT
EET463	ILLUMINATION TECHNOLOGY	PEC	2	1	0	3

Preamble: The basic objective of this course is to deliver the fundamental concepts of illumination engineering in the analysis and design of architectural lighting systems.

Prerequisite: Nil

Course Outcomes: After the completion of the course the student will be able to

CO 1	Explain the fundamental concepts of natural and artificial lighting schemes
CO 2	Design efficient indoor lighting systems
CO 3	Design efficient outdoor lighting systems
CO 4	Describe aesthetic and emergency lighting systems

Mapping of course outcomes with program outcomes

	PO 1	PO 2	PO 3	PO 4	PO 5	PO 6	PO 7	PO 8	PO 9	PO 10	PO 11	PO 12
CO 1	3	2										
CO 2	2	2	3				1					1
CO 3	2	2	3				1					1
CO 4	2	2			3							

Assessment Pattern

Bloom's Category	Continuous Assessment		End Semester Examination
	Tests		
	1	2	
Remember	15	15	30
Understand	15	15	30
Apply	20	20	40
Analyse			
Evaluate			
Create			

Mark distribution

Total Marks	CIE	ESE	ESE Duration
150	50	100	3 hours

Continuous Internal Evaluation Pattern:

ELECTRICAL AND ELECTRONICS

Attendance	: 10 marks
Continuous Assessment Test (2 numbers)	: 25 marks
Assignment/Quiz/Course project	: 15 marks

End Semester Examination Pattern: There will be two parts; Part A and Part B. Part A contain 10 questions with 2 questions from each module, having 3 marks for each question. Students should answer all questions. Part B contains 2 questions from each module of which student should answer any one. Each question can have maximum 2 sub-divisions and carry 14 marks.

Course Level Assessment Questions**Course Outcome 1 (CO1):**

1. Explain the quality of a good lighting (K2 PO1)
2. Select the factors affecting the quality of artificial lighting (K2 PO2)
3. Define MHCP, MSCP. (K1 PO1)

Course Outcome 2 (CO2)

1. Define Maintenance Factor.(K1 PO1)
2. Problems related to design of indoor lighting systems.(K2 PO2 PO3 PO7)
3. What are the special features that must be taken care of while illuminating staircase. (K2 PO2 PO12)

Course Outcome 3(CO3):

1. Select the main factors for designing street/road lighting? .(K2 PO2 PO3 PO12)
2. Problems related to design of Flood Lighting system?(K2 PO2 PO3 PO7)
3. With a neat diagram give the application of Track Fixtures.(K2 PO2 PO3)

Course Outcome 4 (CO4):

1. Explain at least Five features of monument lighting.(K2 PO1 PO2)
2. What are the different factors to be considered while designing aesthetic illumination of bridges and statues? .(K2 PO1 PO2 PO5)
3. Selection of luminaries for different areas in hospitals? .(K2 PO1 PO2 PO5)

Model Question Paper

ELECTRICAL AND ELECTRONICS

QP CODE:

PAGES:

Reg No: _____

Name : _____

**APJ ABDUL KALAM TECHNOLOGICAL UNIVERSITY
SEVENTH SEMESTER B.TECH DEGREE EXAMINATION,
MONTH & YEAR**

Course Code: EET463

Course Name: ILLUMINATION TECHNOLOGY

Max. Marks: 100

Duration: 3 Hours

PART A (10X3=30marks)

Answer all Questions. Each question carries 3 Marks

1. What are the different schemes of artificial lighting?
2. Explain with neat diagram the different types of artificial lighting system used.
3. Explain how photometric bench is used for measuring candle power of a test lamp
4. Explain how illumination can be calculated for Line source and Surface source.
5. Illustrate at least five fixtures used for outdoor lighting?
6. Define Space to Mounting height ratio
7. How are the projectors in flood lighting classified according to the beam?
8. What are different methods available for aiming the lamp in flood lighting?
9. List out the requirements of a good Sport lighting.
10. List out and explain at least five features of auditorium lighting

PART B

Answer any one full question from each module. Each question carries 14 Marks

Module-1

11(a) What is the impact of stroboscopic effect on visual comfort in an artificial lighting scheme? How the effect can be reduced

11(b) Explain with neat diagram the different types of artificial lighting system used.

12(a) Explain Colour rendering and stroboscopic effect

12(b) What is a glare? How it is classified.

Module-2

13(a) Four lamps 15m apart are arranged to illuminate a corridor. Each lamp is mounted at a height of 8m above the floor level. Each lamp gives 450 Cd in all directions below the horizontal. Find the illumination at the midway between 2nd and 3rd lamp

13(b) Illustrate with a neat diagram the concept of polar curve in illumination technology

14(a) State the Laws of Illumination

14(b) Explain with neat figures a.) Inverse square law b.) Lambert's Cosine law

Module-3

15(a) Specify the need of DLOR and ULOR in artificial architectural lighting. List out three factors on which DLOR and ULOR depends

15(b) Illustrate at least five fixtures used for interior lighting?

16(a) Define

1. Coefficient of utilisation
2. Depreciation factor

16(b) A drawing hall in an engineering college is to be illuminated with a lighting installation. The hall is $30\text{m} \times 20\text{m} \times 8\text{m}$ (high). The mounting height is 5m and the required level of illumination is 144 lm/m^2 . Using metal filament lamps, estimate the size and number of single lamp luminaries and draw their spacing layout. Assume: Utilization factor = 0.6, MF = 0.75; Space/Height = 1. Lumens/ Watt for 300-W lamp = 13, Lumens/Watt for 500-W lamp = 16

Module-4

17(a) How are the projectors in flood lighting classified according to the beam?

17 b) Describe the area of application of each type of flood light.

18(a) Illustrate at least five fixtures used for outdoor lighting?

18(b) Explain the various types of lamps used in street lighting.

Module-5

19a) What are different factors to be considered while designing aesthetic illumination of bridges and statues?

19 b) What is the importance of modelling and shadows in the case of sports field lighting?

20 a) Describe any five characteristics of statue lighting

20(b) During the Onam week celebration organised by the Dept. of Tourism, it is a customary to illuminate the Kerala Secretariat Building and the arterial road in the capital city in different colours. As an illumination engineer what are the different factors which must be considered for

- i) Illuminating the Secretariat building
- ii) The roads way aesthetic lighting
- iii) A Statue in front of Secretariat building

Syllabus

Module 1

Introduction of Light: Types of illumination, Day lighting, Artificial light sources- artificial lighting and total lighting, Quality of good lighting, Factors affecting the Physical processes- Incandescent and Halogen lamps, Fluorescent lamps, LPSV and HPSV lamps, mercury vapour lamps, metal halide lamps, LED lamps- modern trends. Supplementary lighting- shadow, glare, reflection, Colour rendering and stroboscopic effect, Methods of artificial lighting, Lighting systems- direct, indirect, semi direct, semi indirect, Lighting scheme, General and localised, Different types of Luminaires

Module 2

Measurement of Light: Definition of luminous flux, Luminous intensity, Lumen, Candle power, Illumination, M.H.C.P, M.S.C.P, M.H.S.C.P, Lamp efficiency, Brightness or luminance, Laws of illumination, Inverse square law and Lambert's Cosine law, Illumination at horizontal and vertical plane from point source, Concept of polar curve, Calculation of luminance and illumination in case of linear source, round source and flat source. Measuring apparatus- Goniophotometer, Integrating sphere, lux meter.

Module 3

Design of Interior Lighting: Definitions of maintenance factor, Uniformity ratio, Direct ratio, Coefficients of utilisation and factors affecting it, Illumination required for various work planes, Types of fixtures and relative terms used for interior illumination such as DLOR and ULOR, Selection of lamp and luminance, Selection of utilisation factor, reflection factor and maintenance factor, Determination of Lamp Lumen output taking into account voltage and temperature variations, Calculation of wattage of each lamp and no of lamps needed, Layout of lamp luminaire, Calculation of space to mounting height ratio, Indian standard recommendation and standard practices for illumination levels in various areas, Special feature for entrance, staircase, Corridor lighting and industrial building.

Module 4

Design of Outdoor Lighting: Street Lighting - Types of street and their level of illumination required, Terms related to street lighting, Types of fixtures used and their suitable application, Various arrangements in street lighting, Requirements of good street lighting, Selection of lamp and luminaire, Calculation of illumination level available on road. Tunnel

Lighting, Calculation of their wattage and number and their arrangement, Calculation of space to mounting height ratio.

Flood Lighting: Terms related to flood lighting, Types of fixtures and their suitable applications, Selection of lamp and projector, recommended method for aiming of lamp, Calculation of their wattage and number and their arrangement, Calculation of space to mounting height ratio.

Module 5

Special Features of Aesthetic Lighting: Monument and statue lighting, Sports lighting, Hospital lighting, Auditorium lighting

General Aspects of emergency lighting. Lighting controllers – dimmers, motion and occupancy sensors, photo sensors and timers. Lighting system design using software (eg: DIALux and Relux).

Note: Case study of indoor and outdoor lighting design using software may be given as assignment.

Text Books

1. D.C. Pritchard Lighting, Routledge, 2016
2. Jack L. Lindsey, Applied Illumination Engineering, PHI, 1991

References:

1. John Matthews Introduction to the Design and Analysis of Building Electrical Systems, Springer, 1993
2. M.A. Cayless, Lamps and Lighting , Routledge, 1996
3. Craig DiLouie, Advanced Lighting Controls: Energy Savings, Productivity, Technology and Applications, CRC Press, 2005.
4. Lighting Engineering Applied calculations R. H. Simons and A. R. Bean, Routledge; 1st edition, 2020

Course Contents and Lecture Schedule

No	Topic	No. of Lectures
1	Introduction of Light (7 hours)	
1.1	Types of illumination, Day lighting.	1
1.2	Artificial light sources-Physical processes- Incandescent and Halogen lamps, Fluorescent lamps, LPSV and HPSV lamps, mercury vapour lamps, metal halide lamps, LED lamps- modern trends.	2
1.3	Supplementary artificial lighting and total lighting, Quality of good lighting, Factors affecting the lighting-shadow, glare, reflection, Colour	2

	rendering and stroboscopic effect.	
1.4	Methods of artificial lighting, Lighting systems-direct, indirect, semi direct, semi indirect, Lighting scheme, General and localised, Different types of Luminaires.	2
2	Measurement of Light. (7 hours)	
2.1	Definition of luminous flux, Luminous intensity, Lumen, Candle power, Illumination, M.H.C.P, M.S.C.P, M.H.S.C.P, Lamp efficiency, Brightness or luminance.	2
2.2	Laws of illumination, Inverse square law and Lambert's Cosine law, Illumination at horizontal and vertical plane from point source.	2
2.3	Concept of polar curve, Calculation of luminance and illumination in case of linear source, round source and flat source.	2
2.4	Measuring apparatus- Goniophotometer, Integrating sphere, lux meter.	1
3	Design of Interior Lighting (8 Hours)	
3.1	Definitions of maintenance factor, Uniformity ratio, Direct ratio, Coefficients of utilisation and factors affecting it, Illumination required for various work planes.	2
3.2	Types of fixtures and relative terms used for interior illumination such as DLOR and ULOR, Selection of lamp and luminance, Selection of utilisation factor, reflection factor and maintenance factor.	2
3.3	Determination of Lamp Lumen output taking into account voltage and temperature variations, Calculation of wattage of each lamp and no of lamps needed, Layout of lamp luminaire, Calculation of space to mounting height ratio.	2
3.4	Indian standard recommendation and standard practices for illumination levels in various areas, Special feature for entrance, staircase, Corridor lighting and industrial building.	2
4	Design of Outdoor Lighting (10 Hours)	
4.1	Street Lighting - Types of street and their level of illumination required, Terms related to street and street lighting, Types of fixtures used and their suitable application.	2
4.2	Various arrangements in street lighting, Requirements of good street lighting, Selection of lamp and luminaire, Calculation of illumination level available on road. Calculation of their wattage and number and their arrangement, Calculation of space to mounting height ratio.	2
4.3	Tunnel Lighting, Calculation of their wattage and number and their	2

	arrangement, Calculation of space to mounting height ratio.	
4.4	Flood Lighting: Terms related to flood lighting, Types of fixtures and their suitable applications, Selection of lamp and projector, Recommended method for aiming of lamp.	2
4.5	Flood Lighting: Calculation of their wattage and number and their arrangement, Calculation of space to mounting height ratio.	2
5	Special Features of Aesthetic and Emergency lighting (6 Hours)	
5.1	Monument and statue lighting, Sports lighting	2
5.2	Hospital lighting, Auditorium lighting	1
5.3	General Aspects of emergency lighting, Lighting controllers – dimmers, motion and occupancy sensors, photo sensors and timers	2
5.4	Lighting system design using software	1

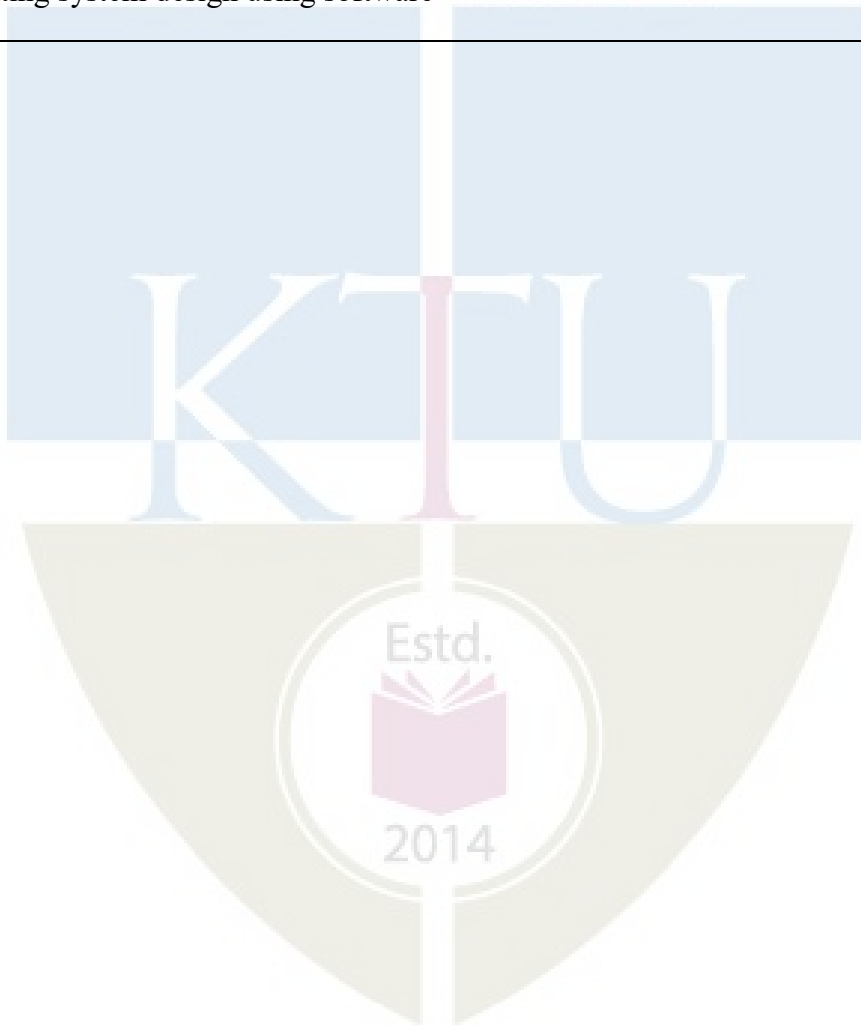

CODE	COURSE NAME	CATEGORY	L	T	P	CREDIT
EET473	DIGITAL PROTECTION OF POWER SYSTEMS	PEC	2	1	0	3

Preamble: The basic objective of this course is to deliver fundamental concepts to design various electronic circuits to implement various relaying functions. The relays such as Static Relays, Microprocessor based protective relays, Digital relay Travelling wave based protection and adaptive relaying is comprehensively covered in this course. It should be also useful to practicing engineers and the research community.

Prerequisite : 1) EET 301 Power Systems I
2) EET 304 Power Systems II

Course Outcomes: After the completion of the course the student will be able to

CO 1	Identify the relay protection scheme suitable for over current, differential and distance protection.
CO 2	Develop the protection scheme for bus bars, transformers, generators, motors and distribution systems using appropriate protective relays.
CO 3	Illustrate the operation of a numerical relay in his/her own way.
CO 4	Explain signal processing methods and algorithms in digital protection.
CO 5	Infer emerging protection schemes in power systems.

Mapping of course outcomes with program outcomes

	PO 1	PO 2	PO 3	PO 4	PO 5	PO 6	PO 7	PO 8	PO 9	PO 10	PO 11	PO 12
CO 1	3	2	-	-	-	-	-	-	-	-	-	-
CO 2	3	3	3	-	-	-	-	-	-	-	-	-
CO 3	3	2	3	-	-	-	-	-	-	-	-	-
CO 4	3	2	3	-	-	-	-	-	-	-	-	-
CO 5	3	3	-	2	-	-	-	-	-	-	-	-

Assessment Pattern

Bloom's Category	Continuous Assessment Tests		End Semester Examination
	1	2	
Remember	10	10	30
Understand	20	20	40
Apply	20	20	30
Analyse			
Evaluate			
Create			

Mark distribution

Total Marks	CIE	ESE	ESE Duration
150	50	100	3 hours

Continuous Internal Evaluation Pattern:

Attendance : 10 marks

Continuous Assessment Test (2 numbers) : 25 marks

Assignment/Quiz/Course project : 15 marks

End Semester Examination Pattern: There will be two parts; Part A and Part B. Part A contain 10 questions with 2 questions from each module, having 3 marks for each question. Students should answer all questions. Part B contains 2 questions from each module of which student should answer any one. Each question can have maximum 2 sub-divisions and carry 14 marks.

Course Level Assessment Questions**Course Outcome 1 (CO1):**

1. Discuss how saturation affects the accuracy of C.T.s. (K2)
2. Why I.D.M.T. relays are widely used for over current protection (K2))
3. Develop a criteria for the selection off distance relays.(K3)

Course Outcome 2 (CO2)

1. In what way distance protection is superior to over current protection for the protection of transmission lines.(K2)
2. Discuss the working principle of frame leakage protection.(K2)
3. Explain the differential scheme for bus zone protection.(K1)

Course Outcome 3(CO3):

1. Explain the principle of operation of numerical relays. (K1)
2. What is the function of the sample and hold circuit.(K2)
3. Explain the sliding window concept.(K2)

Course Outcome 4 (CO4):

1. Explain the concept of Finite Impulse Response filters,(K2)
2. Explain sinusoidal wave based algorithms. (K1)
3. Explain Least squares based algorithm. (K1)

Course Outcome 5 (CO5):

ELECTRICAL AND ELECTRONICS

1. Compare the different decision making schemes in protective relays.(K2)
2. Explain the concept of synchronized sampling. (K2)
3. What are the basic components of a phasor measurement unit.(K1)

Model Question Paper

QP CODE:

PAGES:4

Reg.No: _____

Name: _____

APJ ABDUL KALAM TECHNOLOGICAL UNIVERSITY
SEVENTH SEMESTER B.TECH DEGREE EXAMINATION,
MONTH & YEAR

Course Code: EET473

Course Name : DIGITAL PROTECTION OF POWER SYSTEMS

Max. Marks: 100
Hours

Duration: 3

PART A (3 x 10 = 30 Marks)

Answer all Questions. Each question carries 3 Marks

1. Explain the basic principle and characteristics of impedance relays.
2. Explain current setting and time setting.
3. Explain the effect of power swings on the performance of distance relays.
4. What are the features of directional protection schemes for distribution system.
5. Give a comparison of numerical relays with static relays.
6. What are the basic components of numerical relays. Explain
7. Why digital filtering is required in a digital relay. Explain.
8. What are the useful properties of finite impulse filter.
9. What are the advantages of adaptive relaying
10. Give the definition of wide-area protection

PART B (14 x 5 = 70 Marks)

Answer any one full question from each module. Each question carries 14 Marks

Module 1

- 11.a) Explain the time current characteristics of inverse, very inverse and extremely inverse over current relays. Discuss their area of applications 7
- b) What are the requirements of C.T. s used for protection. 7
- 12.a) Explain the types of construction used for P.T.s. 7
- b) Explain the basic principle and characteristics of reactance and mho relays. 7

Module 2

- 13.a) With the help of a schematic diagram explain the carrier current protection scheme. 7
- b) With the help of a neat diagram explain the working of harmonic restraint relay. 7
- 14.a) Explain the Phase comparison line protection scheme. 7
- b) Explain the loss of excitation protection for a generator. 7

Module 3

- 15.a) With the help of a block diagram explain the basic components of a digital relay. 8
- b) Explain the communication in protective relays (IEC 61850) 6
- 16.a) Briefly explain the information handling with substation automation system. 7
- b) Explain the signal conditioning subsystem in numerical relays. 7

Module 4

- 17.a) Explain the full cycle window algorithm. 8
- b) Give a comparison between infinite impulse filter and finite impulse filter. 6
- 18.a) Give the basic formulation of sample and first derivative method in sinusoidal wave based algorithm. 8
- b) Explain how the impedance to the fault is found by using Least square method. 6

Module 5

- 19.a) Explain the methods of deterministic decision making and decision making with multiple criteria in protective relays. 8
- b) Explain the architectures of wide-area protection 6
- 20.a) Explain the concept of Adaptive relaying and its applications. 8
- b) Explain the Adaptive Differential protective scheme. 6

Syllabus

Module 1 (8 hours)

Introduction: Need for protective systems, Zones of protection, Current transformers and voltage transformers (Electromagnetic and Capacitive voltage transformers), Principle of operation of magneto optic CT/ PT, effect on relaying philosophy.

Relays: Over current relays - time-current characteristics of over current relays: definite time over current relays, inverse Definite Minimum time - directional over current relays, current setting and time setting - Numerical Problems - Differential relays: Operating and restraining characteristics, types of differential relays, Distance relays: impedance relays, reactance relays, mho relays, quadrilateral relays, elliptical relays (basic principles and characteristics only).

Module 2 (8 hours)

Protection of Transmission Line Systems: Schemes of distance protection, Differential line protection, Phase comparison line protection, Use of line carrier and communication links, Effect of power swings on the performance of distance relays.

Protection of Bus-bar, Transformer and Generator & Motor Systems: Types of faults, differential protection: High impedance and low impedance differential protection schemes, harmonic restraint relay, Restricted Earth Fault Protection, frame leakage protection, stator and rotor protection against various types of faults.

Pilot relaying schemes: Pilot wire protection, carrier current protection (Basic Principles and schematic).

Protection Scheme for Distribution Systems: Protection criteria for distribution system, Features of directional and non-directional protection schemes for distribution system, Fundamentals of travelling wave protection scheme.

Module 3 (8 hours)

Introduction to Digital (Numerical) Relays- Basic Components of numerical Relays with block diagram, Processing Unit, Human machine Interface, Principle of operation- Comparison of numerical relays with electromechanical and static relays, Advantages of numerical relays - communication in protective relays (IEC 61850), Information handling with substation automation system (SAS)

Signal Conditioning Subsystems: Surge Protection Circuits, Anti-aliasing filter, Conversion Subsystem, The Sampling Theorem, aliasing, Sample and Hold Circuit, Concept of analog to digital and digital to analog conversion, Idea of sliding window concept, Fourier, Discrete and fast Fourier transforms

Module 4 (6 hours)

Signal processing techniques: Sinusoidal wave based algorithms, Fourier Analysis based algorithms (half cycle and full cycle), Least squares based algorithm.

Digital filters – Fundamentals of Infinite Impulse Response Filters, Finite Impulse Response filters, Filters with sine and cosine windows

Module 5 (6 hours)

Decision making in Protective Relays – Deterministic decision making, Statistical Hypothesis testing, Decision making with multiple criteria, Adaptive decision schemes.

Wide Area Protection and Measurement: Phasor Measurement Units, concept of synchronized sampling, Definition of wide-area protection, Architectures of wide-area protection, concept of Adaptive relaying, advantages of adaptive relaying and its application, Adaptive Differential protective scheme.

Assignment - Simulation of protection schemes using SIMULINK

Text/References Books

1. A. T. Johns and S. K. Salman, "Digital Protection for Power Systems," Peter Peregrinus Ltd, UK, 1995.
2. Waldemar Rebizant, Digital Signal Processing in Power System Protection and Control –Springer Publication
3. J. L. Blackburn, "Applied Protective Relaying," Westinghouse Electric Corporation, New York, 1982.
4. A. G. Phadke and J. S. Thorp, "Computer Relaying for Power Systems," Research study press Ltd, John Wiley & Sons, Taunton, UK, 1988.
5. S.P Patra, S.K Bl,lsu and S. Choudhary, "Power System Protection", Oxford IBH Pub.
6. S. Ravindernath and M. Chander, "Power System Protection and Switchgear", Wiley Eastern Ltd.
7. Badri Ram and Vishwakarma, Power System Protection and Switchgear, A McGraw Hill.
8. Digital Signal Processing in Power System Protection and Control by Waldemar Rebizant, Janusz Szafran ,Andrzej Wiszniewski - Springer publication

Course Contents and Lecture Schedule:

No	Topic	No. of Lectures
1	Introduction to protective relays (8 hours)	
1.1	Introduction: Need for protective systems, Zones of protection, Current transformers and voltage transformers (Electromagnetic and Capacitive voltage transformers), Principle of operation of magneto optic CT/ PT, effect on relaying philosophy.	2
1.2	Relays: Over current relays-time-current characteristics of over current	2

	relays: definite time over current relays, inverse Definite Minimum time -directional over current relays, current setting and time setting- Numerical Problems	
1.3	Differential relays: Operating and restraining characteristics, types of differential relays,	1
1.4	Distance relays: impedance relays, reactance relays, mho relays, quadrilateral relays, elliptical relays (basic principles and characteristics only).	3
2	Protection of Transmission, Distribution, Bus-bar, Transformer, Generator & Motor Systems (8 hours)	
2.1	Protection of Transmission Line Systems: Schemes of distance protection, Differential line protection, Phase comparison line protection, Use of line carrier and communication links, Effect of power swings on the performance of distance relays.	2
2.2	Protection of Bus-bar, Transformer and Generator & Motor Systems: Types of faults, differential protection: High impedance and low impedance differential protection schemes, harmonic restraint relay, Restricted Earth Fault Protection, frame leakage protection, stator and rotor protection against various types of faults.	3
2.3	Pilot relaying schemes: Pilot wire protection, carrier current protection (Basic Principles and schematic) .	1
2.4	Protection Scheme for Distribution Systems: Protection criteria for distribution system, Features of directional and non-directional protection schemes for distribution system, Fundamentals of travelling wave protection scheme.	2
3	Introduction to Digital (Numerical) Relays (8 hours)	
3.1	Basic Components of numerical Relays with block diagram, Processing Unit, Human machine Interface, Principle of operation- Comparison of numerical relays with electromechanical and static relays, Advantages of numerical relays	3
3.2	Communication in protective relays (IEC 61850), Information handling with substation automation system (SAS)	1
3.3	Signal Conditioning Subsystems: Surge Protection Circuits, Anti-aliasing filter, Conversion Subsystem, The Sampling Theorem, aliasing, Sample and Hold Circuit, Concept of analog to digital and digital to analog conversion	3
3.4	Idea of sliding window concept, Fourier, Discrete and fast Fourier transforms	1

4	Signal processing techniques (6 hours)	
4.1	Signal processing techniques: Sinusoidal wave based algorithms, Fourier Analysis based algorithms (half cycle and full cycle), Least squares based algorithm	3
4.2	Digital filters – Fundamentals of Infinite Impulse Response Filters, Finite Impulse Response filters, Filters with sine and cosine windows	3
5	Decision making in Protective Relays (6 hours)	
5.1	Decision making in Protective Relays – Deterministic decision making, Statistical Hypothesis testing, Decision making with multiple criteria, Adaptive decision schemes.	2
5.2	Wide Area Protection and Measurement: Phasor Measurement Units, concept of synchronized sampling, Definition of wide-area protection, Architectures of wide-area protection	2
5.3	concept of Adaptive relaying, advantages of adaptive relaying and its application, Adaptive Differential protective scheme.	2

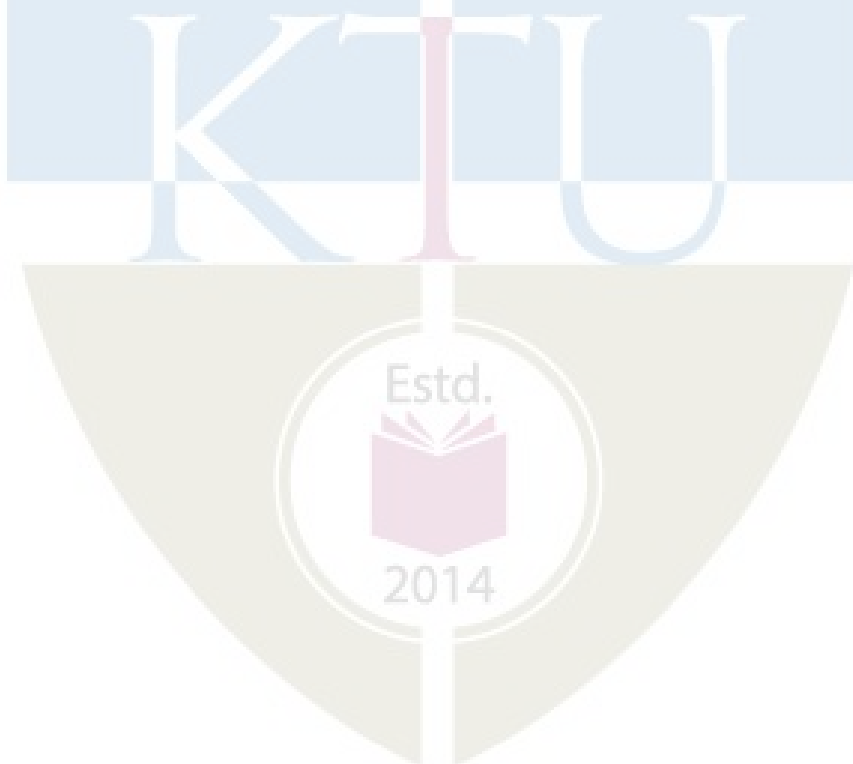

CODE	COURSE NAME	CATEGORY	L	T	P	CREDIT
EET415	CONTROL SYSTEMS ENGINEERING	OEC	2	1	0	3

Preamble: Control Engineering is not limited to any engineering discipline, but is equally applicable to mechanical, chemical, electrical, aeronautical engineering. The most characteristic quality of control engineering is the opportunity to control machines, industrial and economic process for the benefit of society. This course aims to provide a strong foundation on classical control theory. In this course modelling, time domain analysis, frequency domain analysis and stability analysis of linear systems based on transfer function approach will be discussed.

Prerequisite: Knowledge of Laplace transforms.

Course Outcomes: After the completion of the course the student will be able to:

CO 1	Identify the elements of control system.
CO 2	Develop transfer function models of systems.
CO 3	Analyse the relation between pole locations with the transient response of first and second order systems.
CO 4	Determine the stability of LTI systems.
CO 5	Apply the concept of Root locus to assess the performance of linear systems.
CO 6	Determine the frequency domain specifications from Bode plot, Polar plot and Nyquist plot.

Mapping of course outcomes with program outcomes

	PO 1	PO 2	PO 3	PO 4	PO 5	PO 6	PO 7	PO 8	PO 9	PO 10	PO 11	PO 12
CO 1	3	2	-	-	-	-	-	-	-	-	-	1
CO 2	3	2	-	-	-	-	-	-	-	-	-	1
CO 3	3	2	-	-	2	-	-	-	-	-	-	1
CO 4	3	2	-	-	-	-	-	-	-	-	-	1
CO 5	3	2	-	-	2	-	-	-	-	-	-	1
CO 6	3	2	-	-	2	-	-	-	-	-	-	1

Assessment Pattern

Bloom's Category	Continuous Assessment Tests		End Semester Examination
	1	2	
Remember	10	10	20
Understand	20	20	40
Apply	20	20	40
Analyse			
Evaluate			
Create			

Mark distribution

Total Marks	CIE	ESE	ESE Duration
150	50	100	3 hours

Continuous Internal Evaluation Pattern:

Attendance : 10 marks

Continuous Assessment Test (2 numbers) : 25 marks

Assignment/Quiz/Course project : 15 marks

End Semester Examination Pattern: There will be two parts; Part A and Part B. Part A contain 10 questions with 2 questions from each module, having 3 marks for each question. Students should answer all questions. Part B contains 2 questions from each module of which student should answer any one. Each question can have maximum 2 sub-divisions and carry 14 marks.

Course Level Assessment Questions:**Course Outcome 1 (CO1)**

1. Explain with an example how does the feedback element affects the performance of a closed loop system. (K3, PO1, PO2 and PO12)
2. What is the function of controller and sensor in a closed loop system? (K2, PO1)
3. What are the modifications required to convert an open loop system to a closed loop system? (K1, PO1, PO12)

Course Outcome 2 (CO2)

1. Problems related to derivation of transfer function of mechanical systems. (K3, PO1 and PO12)
2. Define transfer function and derive the transfer function of an RC network. (K3, PO1, PO2 and PO12)
3. Write short notes on Force- voltage and Force – current analogy? (K1, PO1, PO12)

Course Outcome 3 (CO3)

1. What is the effect of location of roots on S-plane on the transient response of a system? (K1, PO1, PO12)
2. What is the change in transient response of a second order system due to the addition of poles? Illustrate with an example. (K1, PO1, PO2, PO12)
3. What is the significance of settling time in control system? (K1, PO1, PO12)

Course Outcome 4 (CO4)

1. Problems related to application of Routh's stability criterion for analysing the stability of a given system. (K3, PO1, PO2, PO12)
2. Plot the impulse response of a second order system for different location of poles on S-plane. (K3, PO1, PO2, PO12)

3. How can we relate asymptotic stability to location of roots of characteristic equation?
K2, PO1, PO2, PO12)

Course Outcome 5 (CO5)

1. Determine the value of K such that the closed loop system with $G(s)H(s) = \frac{K}{s(s+1)(s+4)}$ is oscillatory, using Root locus. (K3, PO1, PO2, PO12)
2. Construct the Root locus for the closed loop system with $G(s)H(s) = \frac{K}{s(s^2+2s+2)}$ and determine the value of K to achieve a damping factor of 0.5. (K3, PO1, PO2, PO12)
3. Problems on root locus for systems with positive feedback. (K3, PO1, PO2, PO12)

Course Outcome 6 (CO6)

1. Problems related to assess the stability of the given system using Bode plot. (K3, PO1, PO2, PO3, PO12)
2. Problems related to Polar plot. (K3, PO1, PO2, PO12)
3. Explain Nyquist stability criterion. (K2, PO1, PO2, PO12)

Model Question Paper

PAGES: 2

QPCODE:

Reg. No: _____

Name: _____

APJ ABDUL KALAM TECHNOLOGICAL UNIVERSITY

SEVENTH SEMESTER B.TECH DEGREE EXAMINATION

MONTH & YEAR

Course Code: **EET415**

Course Name: **CONTROL SYSTEMS ENGINEERING**

Max. Marks: 100

Duration: 3 Hours

PART A

Answer all Questions. Each question carries 3 Marks

1. Write short notes on Force- voltage and Force – current analogy?
2. Explain Mason's gain formula?
3. Define damping ratio.
4. Derive and sketch the time response of a first order system.
5. What are dynamic error coefficients? What are their merits?
6. Define BIBO Stability. What is the requirement of BIBO Stability?
7. How to determine break away and break in point in root locus plot?
8. What is the significance of dominant pole?
9. Write a short note on the correlation between time and frequency response
10. Explain Nyquist stability criterion

PART B ELECTRICAL AND ELECTRONICS

Answer any one full question from each module. Each question carries 14 Marks

Module 1

9. a. Derive the transfer function for the mechanical system shown in figure. 10

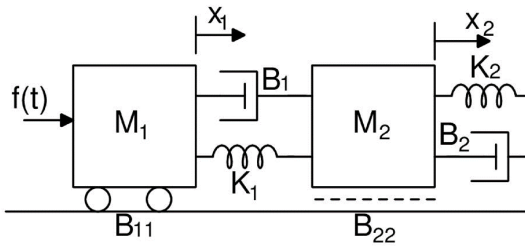

b. Distinguish between open loop system and closed loop system 4

10. a. Reduce the block diagram shown in figure 10

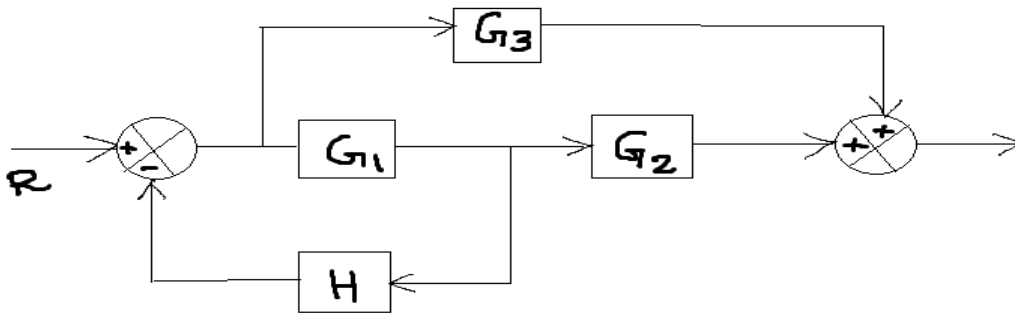

b. Define transfer function and derive the transfer function of an RC network 4

Module 2

11 a. Sketch the time response of a general second order underdamped system and explain the specifications 6

b. The damping ratio of a system is 0.6 and the natural frequency of oscillation is 8 rad/sec. Determine the rise time, peak overshoot and peak time 8

12a. Distinguish between type and order of a system 5

b. The open loop transfer function of a unity feedback system is

$$G(s) = 20/s(s + 10)$$

What is the nature of response of closed loop system for unit step input? 9

Module 3

13 a. Plot the impulse response of a second order system for different location of poles on S-plane. 9

b. What is the effect of location of roots on S-plane on the transient response of a system? 5

14 a. A unity feedback system has a open loop transfer function of 7

$$G(s) = 10/(s + 1)(s + 2)$$

Determine steady state error for unit step input

b. Using Routh criterion determine the value of K for which the unity feedback closed

loop system with $G(s) = \frac{K}{s(s^2 + 20s + 8)}$ is stable. 7

Module 4

- 15 a. What is the relation between stability and coefficient of characteristic polynomial? 2
 b. Explain the methods to find the crossing points of Root locus in imaginary axis. 4
 c. Sketch the root locus for the unity feedback system whose open loop transfer function is given by: 8

$$G(s) = \frac{K}{s(s + 4)(s^2 + 4s + 20)}$$

16. Draw the root locus for a unity feedback system having forward path transfer function,

$$G(s) = \frac{K}{s(s+1)(s+5)} \quad 8$$

- (a) Determine value of K which gives continuous oscillations and the frequency of oscillation.
 (b) Determine the value of K corresponding to a dominant closed loop pole with damping ratio 0.7 6

Module 5

17. Consider a unity feedback system having an open loop transfer function

$$G(s) = k/s(1 + 0.2s)(1 + 0.05s)$$

- (a) Sketch the polar plot 8
 (b) Determine the value of K so that
 (i) Gain margin is 18 db
 (ii) Phase margin is 60° 6

18. (a) The open loop transfer function of a system is given by

$$G(s) = k/s(1 + 0.2s)(1 + 0.5s)$$

Sketch the Bode plot 8

(b) From the Bode plot determine the value of K so that

- (i) Gain margin of the system is 6 db
- (ii) Phase margin of the system is 25°

Syllabus

Module 1

Feedback Control Systems (10 hours)

Open loop-and closed loop control systems: Transfer function of LTI systems- Mechanical and Electromechanical systems – Force voltage and force current analogy - block diagram representation - block diagram reduction - signal flow graph - Mason's gain formula - characteristic equation..

Module 2

Performance Analysis of Control Systems (5 hours)

Time domain analysis of control systems: Transient and steady state responses - time domain specifications - first and second order systems - step responses of first and second order systems.

Module 3

Error Analysis and Stability (6 hours)

Error analysis: Steady state error analysis and error constants -Dynamic error coefficients.

Stability Analysis: Concept of BIBO stability and Asymptotic stability- Time response for various pole locations- stability of feedback systems - Routh's stability criterion-

Module 4

Root Locus Technique (6 hours)

Root locus technique: Construction of Root locus- stability analysis- effect of addition of poles and zeroes.

Module 5

Frequency Domain Analysis (9 hours)

Frequency domain specifications- correlation between time domain and frequency domain responses.

Polar plot: Concepts of gain margin and phase margin- stability analysis

Bode Plot: Construction- Concepts of gain margin and phase margin.

Nyquist stability criterion (criterion only)

Text books

1. Nagarath I. J. and Gopal M., Control System Engineering, 5/e, New Age Publishers
2. Ogata K, Modern Control Engineering, 5/e, Prentice Hall of India.
3. Nise N. S, Control Systems Engineering, 6/e, Wiley Eastern
4. Dorf R. C. and Bishop R. H, Modern Control Systems, 12/e, Pearson Education

Reference Books

1. Kuo B. C, Automatic Control Systems, 7/e, Prentice Hall of India
2. Desai M. D., Control System Components, Prentice Hall of India, 2008
3. Gopal M., Control Systems Principles and Design, 4/e, Tata McGraw Hill.
4. Imthias Ahamed T. P, Control Systems, Phasor Books, 2016

Course Contents and Lecture Schedule:

Module	Topic coverage	No. of Lectures
1	Feedback Control Systems (10 hours)	
1.1	Terminology and basic structure of Open loop and Closed loop control systems- Examples of Automatic control systems (block diagram representations only).	2
1.2	Transfer function approach to feed back control systems- Mechanical and Electromechanical systems	2
1.3	Force –voltage , force –current analogy.	2
1.4	Block Diagram Reduction Techniques.	2
1.5	Signal flow graph- Mason's gain formula, Characteristic Equation.	2
2	Performance Analysis of Control Systems (5 hours)	
2.1	Time domain analysis of control systems: Transient and steady state responses- Impulse and Step responses of first and second order systems Time domain specifications.	4
2.2	Time domain specifications.	1
3	Error analysis and Stability(6 hours)	
3.1	Error analysis: Steady state error analysis - static error coefficient of Type 0, 1, 2 systems. Dynamic error coefficients.	2
3.2	Stability Analysis: Concept of stability-BIBO stability and Asymptotic stability- Time response for various pole locations- stability of feedback systems.	2
3.3	Application of Routh's stability criterion to control system analysis- Relative stability.	2
4	Root Locus Technique (6 hours)	
4.1	Root locus technique: General rules for constructing Root loci – stability from root loci -	5
4.2	Effect of addition of poles and zeros on Root locus	1

5	Frequency domain analysis (9 hours) ELECTRICAL AND ELECTRONICS	
5.1	Frequency domain specifications- correlation between time domain and frequency domain responses.	2
5.2	Polar plot: Concepts of gain margin and phase margin- stability analysis.	2
5.3	Bode Plot: Construction of Bode plots- gain margin and phase margin- Stability analysis based on Bode plot .	4
5.4	Nyquist stability criterion	1

APJ ABDUL KALAM
TECHNOLOGICAL
UNIVERSITY

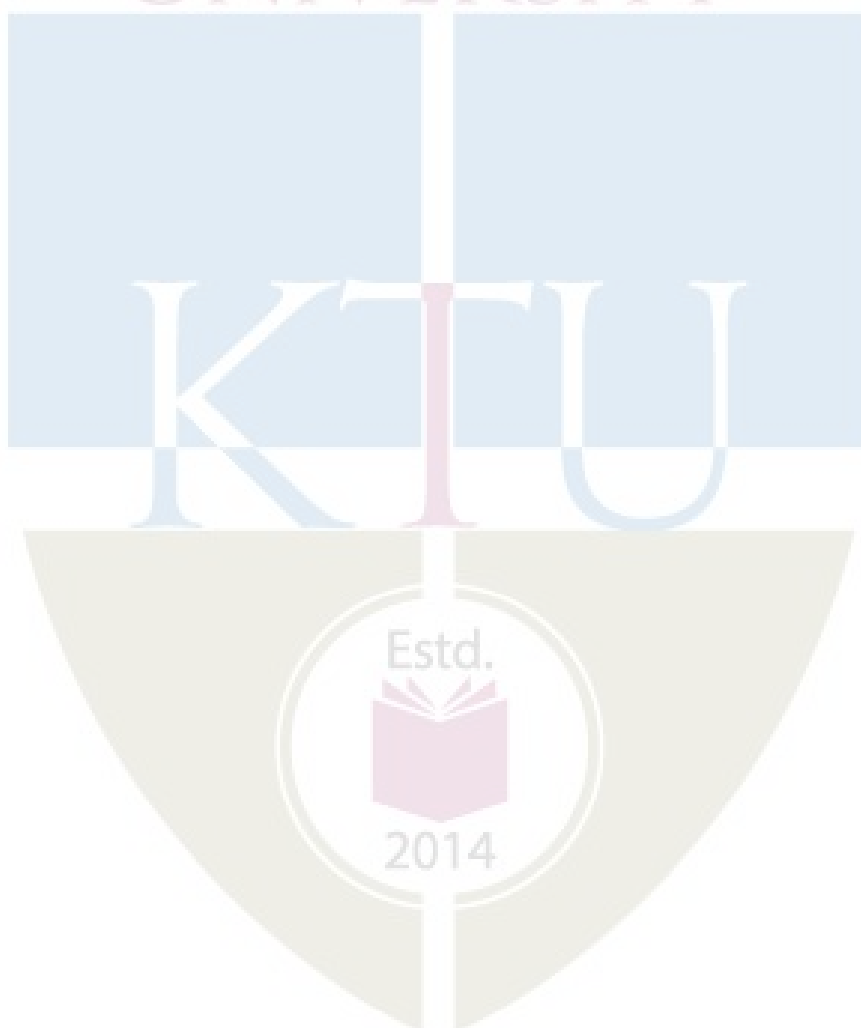

CODE	COURSE NAME	CATEGORY	L	T	P	CREDIT
EET425	INTRODUCTION TO POWER PROCESSING	OEC	2	1	0	3

Preamble: The recent advances in power electronics has resulted in the development of various industrial and household devices/equipment that employ power processing. It is important for engineering professionals to understand the fundamental principles behind such devices/systems. This course provides an overview of various essential elements of power electronics used for power processing, and their principle of operation. Power electronics deals with the processing and control of ‘raw’ electrical power from an electrical source. The power levels handled can vary from a few watts to several hundreds of megawatts. It is an enabling technology with a very wide range of applications. The course contents enable the students to understand the principles of power electronics and provide an introduction to various applications such as industrial drives, renewable energy, power supplies and electrical /hybrid vehicles.

Prerequisite: EST 130 Basics of Electrical and Electronics Engineering

Course Outcomes : After the completion of the course the student will be able to:

CO 1	Explain different elements of power electronics.
CO 2	Explain various power electronic converters.
CO 3	Describe the basic principles of ac and dc motor drives.
CO 4	Describe the structure of power processing systems in power supplies, renewable energy conversion and EVs.

Mapping of course outcomes with program outcomes

	PO 1	PO 2	PO 3	PO 4	PO 5	PO 6	PO 7	PO 8	PO 9	PO 10	PO 11	PO 12
CO 1	2											
CO 2	2											
CO 3	2								2			
CO 4	2						2		2			

Assessment Pattern

Bloom's Category	Continuous Assessment Tests		End Semester Examination
	1	2	
Remember	20	20	40
Understand	30	30	60
Apply			
Analyse			
Evaluate			
Create			

Mark distribution

Total Marks	CIE	ESE	ESE Duration
150	50	100	3 hours

Continuous Internal Evaluation Pattern:

Attendance	: 10 marks
Continuous Assessment Test (2 numbers)	: 25 marks
Assignment/Quiz/Course project	: 15 marks

End Semester Examination Pattern: There will be two parts; Part A and Part B. Part A contain 10 questions with 2 questions from each module, having 3 marks for each question. Students should answer all questions. Part B contains 2 questions from each module of which student should answer any one. Each question can have a maximum of 2 subdivisions and carry 14 marks.

Course Level Assessment Questions**Course Outcome 1 (CO1):**

1. Explain the principle of operation of MOSFET. (K2, PO1)
2. What is the difference between thyristors and controllable switches? (K1, PO1)
3. Why are IGBTs becoming popular in their applications to controlled converters ?
4. Enumerate some applications of IGBTs. (K1, PO1)
5. What are the applications of power electronic systems? (K1, PO1)

Course Outcome 2 (CO2)

1. With a neat circuit and waveforms, explain the working of a boost DC-DC converter.(K2, PO1)
2. With the help of waveform explain sinusoidal pulse width modulation used in single phase inverter. (K2, PO1)
3. Explain the working of a single-phase half bridge square wave inverter with pure R load. Draw the output voltage and output current waveforms.(K2, PO1)
4. Illustrate how a thyristor based 1-phase fully controlled rectifier can be used to convert ac into variable dc. Draw the waveforms of output voltage and output current for both R and RL load at $\alpha= 30$ degree.(K2, PO1)

Course Outcome 3(CO3):

1. Give the classification of DC motors based on their field winding excitation with neat diagrams.(K2, PO9)
2. What is meant by armature reaction? What are its effects on main field flux? (K1, PO9)
3. Explain V/F control of induction motor drives. (K2, PO9)
4. Explain why we use starters for starting a DC motor. (K2, PO9)

Course Outcome 4 (CO4):

1. Explain a standalone solar PV system with a block diagram. (K2, PO7, PO9)
2. Explain the components of a linear power supply. (K2, PO7, PO9)
3. Distinguish between HEV and PHEV. (K2, PO7, PO9)
4. Explain the powertrain in an EV. (K2, PO7, PO9)

Model Question Paper**QP CODE:****PAGES:****Reg. No:** _____**Name:** _____

APJ ABDUL KALAM TECHNOLOGICAL UNIVERSITY
SEVENTH SEMESTER B.TECH DEGREE EXAMINATION,
MONTH & YEAR Course Code: EET425
Course Name: INTRODUCTION TO POWER PROCESSING

Max. Marks: 100**Duration: 3 Hours****PART A (3 x 10 = 30 Marks)****Answer all Questions. Each question carries 3 Marks.**

1. Explain the principle of operation of SCR.
2. What are wide bandgap devices? What are its advantages?
3. With a neat circuit explain the working of single phase fully controlled SCR based bridge rectifiers with R load.
4. With neat circuit, explain the working of a boost DC-DC converter
5. Differentiate between voltage source inverter and current source inverter.
6. With the help of waveform explain sinusoidal pulse width modulation used in single phase inverter.
7. What is meant by armature reaction?
8. Explain why we use starters for starting a DC motor.
9. What is the difference between on grid and off grid Solar PV installations?
10. Give three advantages of electric vehicles over the conventional IC engine driven vehicles.

PART B (14 x 5 = 70 Marks)

Answer any one full question from each module. Each question carries 14 Marks

Module 1

11. (a) What are the advantages, disadvantages and applications of power electronic systems? (10)
- (b) Compare a diode and a thyristor. (4)
12. (a) Describe the working of IGBT. How does latch-up occur in an IGBT? Why are IGBTs becoming popular in their applications to controlled converters? Enumerate some applications of IGBTs. (10)
- (b) With a neat block diagram, explain a typical power electronic system. (4)

Module 2

13. (a) Illustrate how a thyristor based 1-phase fully controlled rectifier can be used to convert ac into variable dc. Draw the waveforms of output voltage and output current for RL load at $\alpha = 30$ degree. (10)
- (b) Discuss the significance of a freewheeling diode. (4)
- 14 (a) Explain with a circuit diagram and necessary waveforms, the working of a buck regulator for continuous current mode. (10)
- (b) Explain the phenomenon of inductive kick. (4)

Module 3

- 15 (a) Explain the working of a single-phase half bridge square wave inverter with pure R load. Draw the output voltage and output current waveforms. (10)
- (b) What is its main drawback? Explain how this drawback is overcome. (4)
- 16 (a) What is an ac voltage controller? List some of its industrial applications. Enumerate its merits and demerits. (7)
- (b) Describe the operation of a single phase ac voltage controller with R load with necessary waveforms. (7)

Module 4

17. (a) With a neat schematic explain the components of an electric drive system (7)
- (b) Explain the four-quadrant operation of a dc motor (7)
- 18 (a) List various control strategies used in induction motor drives (4)
- (b) Explain V/F control of induction motor drives. (10)

Module 5

19. (a) Explain the operation of a grid connected solar PV system with a neat block schematic (7)
 (b) Explain the components of a linear power supply. (7)
20. (a) Distinguish between HEV and PHEV (4)
 (b) Explain different energy storage systems used in Electric Vehicles (10)

Syllabus**Module 1**

Introduction to power processing, elements of power electronics, power semiconductor devices. Uncontrolled, Semiconrolled and Fully controlled switches: Diode, SCR, MOSFETs and IGBTs- principle of operation. Advantages of wide bandgap devices-SiC, GaN.

Module 2

Basic power conversion circuits- converter circuits: Controlled rectifiers: Single- phase fully controlled SCR based bridge rectifier with R and RL load (continuous mode only). Principle of operation and waveforms (No analysis required).

DC-DC Converters (Non-isolated) : Buck, Boost and Buck-Boost converter. Circuit operation, voltage gain and waveforms in continuous conduction mode (No analysis required).

Module 3

Single phase half and full bridge Inverter: Square-wave operation with R load. Types of PWM - single pulse, multiple pulse and sinusoidal PWM. Total Harmonic Distortion(THD).

Three phase voltage source inverter with R load- 120 and 180 degree conduction mode - waveforms

Single phase AC voltage controller with R load- waveforms.

Module 4

Applications: 1. *Motor drives*:

Introduction to electric motor drive- Block diagram

4-quadrant operation of a separately excited dc motor (circuit diagram and waveforms only).

Induction motor drives: Principle of operation- v/f control

Module 5

Applications 2: *Renewable energy*- solar PV installations-off grid and on grid systems: Principle of operation - Block diagram.

Applications 3: *Power supplies* - Principle of operation of linear and switched mode power supply- requirements of power supplies- Isolation, protection and regulation.

Applications 4: *Electric vehicles* - Introduction to HEV, PHEV and BEV-Block schematic of power train. Introduction to energy storage in EVs - Li Batteries, Hydrogen Fuel Cell.

Text/Reference Books

1. Ned Mohan, Tore m Undeland, William P Robbins, “Power electronics converters applications and design”, John Wiley and Sons, 2003.
2. Muhammad H. Rashid, Power Electronics Circuits, Devices and Applications, Pearson Education, 2009.
3. P.S. Bimbhra, Power Electronics, Khanna Publishers, New Delhi, 2012.
4. Dubey G. K. “Fundamentals of Electrical drives” Narosa Publishing House, 1995.
5. Andrzej M. Trzynadlowski, Introduction to Modern Power Electronics, 3rd Edition, Wiley, 2015.
6. Iqbal Hussein, Electric and Hybrid Vehicles: Design Fundamentals, CRC Press, 2003.
7. Abbasi S. A. and N. Abbasi, Renewable Energy Sources and Their Environmental Impact, Prentice Hall of India, 2001.
8. Sawhney G. S., Non-Conventional Energy Resources, PHI Learning, 2012.
9. Non conventional energy sources, NPTEL lecture by Prof.Prathap Haridoss, IIT Chennai.
10. Abad, Gonzalo, ed. Power electronics and electric drives for traction applications. USA: Wiley, 2017.

Estd.



2014

No.	Topic	No. of Lectures
1	Introduction to power processing (6 hours)	
1.1	Introduction to power electronics and its objectives, Advantages, disadvantages, applications, typical power electronic system	1
1.2	Elements of power electronics, power semiconductor devices.	1
1.3	Symbol and principle of operation of diode and SCR	1
1.4	Symbol and principle of operation of MOSFET	1
1.5	Symbol and principle of operation of IGBT	1
1.6	Advantages of wide bandgap devices- SiC, GaN	1
2	Basic power conversion circuits (6 hours)	
2.1	Converter circuits	1
2.2	Single- phase fully controlled SCR based bridge rectifier with R (continuous mode only), Principle of operation and waveforms (No analysis required)	1
2.3	Single- phase fully controlled SCR based bridge rectifier with RL load (continuous mode only), Principle of operation and waveforms (No analysis required)	1
2.4	DC-DC Converters (Non-isolated) : Buck converter. Circuit operation, voltage gain and waveforms in continuous conduction mode (No analysis required).	1
2.5	Boost converter. Circuit operation, voltage gain and waveforms in continuous conduction mode (No analysis required).	1
2.6	Buck-Boost converter. Circuit operation, voltage gain and waveforms in continuous conduction mode (No analysis required).	1
3	Inverter circuits, AC voltage controllers (6 hours)	
3.1	Voltage source inverters	1
3.2	Single phase half and full bridge Inverter-Square-wave operation	1

	with R load	
3.3	Types of PWM - single pulse, multiple pulse and sinusoidal PWM Total Harmonic Distortion (THD)	1
3.4	Three phase voltage source inverter with R load- 120 degree conduction mode - waveforms	1
3.5	Three phase voltage source inverter with R load- 180 degree conduction mode - waveforms	1
3.6	Single phase AC voltage controller with R load- waveforms.	1
4	Applications of power processing in Drives (9 hours)	
4.1	Introduction to electric drives, components of electric drive, advantages of electric drives.	1
4.2	DC motor – principle of operation – back emf – necessity of motor starter-classification,	2
4.3	Four quadrant operation of separately excited DC Motor	2
	Three phase induction motor-squirrel cage and slip ring induction motor, Working principle-synchronous speed, slip	2
4.4	Induction Motor Drives, V/F control	2
5	Applications of power processing in renewable energy generation, power supplies and EVs (5 hours)	
5.1	Solar PV installations-Off grid and On grid	1
5.2	Linear and Switch Mode Power Supplies, Functional Block Diagram and operation	2
5.3	Introduction to Electric Vehicle, Various Types, Types of Energy Storage	2

CODE	COURSE NAME	CATEGORY	L	T	P	CREDIT
EET435	RENEWABLE ENERGY SYSTEMS	OEC	2	1	0	3

Preamble: Objective of this course is to inculcate in students an awareness of new and renewable energy sources.

Prerequisite: Students who have taken EET383 MINOR are not eligible to take this course.

Course Outcomes: After the completion of the course the student will be able to

CO 1	Choose the appropriate energy source depending on the available resources.
CO 2	Explain the concepts of solar thermal and solar electric systems.
CO 3	Illustrate the operating principles of wind, and ocean energy conversion systems.
CO 4	Outline the features of biomass and small hydro energy resources
CO 5	Describe the concepts of fuel cell and hydrogen energy technologies

Mapping of course outcomes with program outcomes

	PO 1	PO 2	PO 3	PO 4	PO 5	PO 6	PO 7	PO 8	PO 9	PO 10	PO 11	PO 12
CO 1	2					1	2					
CO 2	3											
CO 3	3					1	1					
CO 4	3					1	1					
CO 5	3											

Assessment Pattern

Bloom's Category	Continuous Assessment Tests		End Semester Examination
	1	2	
Remember	25	25	50
Understand	20	20	40
Apply	5	5	10
Analyse			
Evaluate			
Create			

Mark distribution

Total Marks	CIE	ESE	ESE Duration
150	50	100	3 hours

Continuous Internal Evaluation Pattern:

Attendance	: 10 marks
Continuous Assessment Test (2 numbers)	: 25 marks
Assignment/Quiz/Course project	: 15 marks

End Semester Examination Pattern: There will be two parts; Part A and Part B. Part A contain 10 questions with 2 questions from each module, having 3 marks for each question. Students should answer all questions. Part B contains 2 questions from each module of which student should answer any one. Each question can have a maximum of 2 subdivisions and carry 14 marks.

Course Level Assessment Questions**Course Outcome 1 (CO1):**

1. Write short notes on the advantages and disadvantages of any three types of non conventional energy sources.(K1, PO1)
2. What are the points to be considered while constructing a house for energy efficiency? (K2, PO1, PO6, PO7)

Course Outcome 2 (CO2)

1. Explain construction of solar flat plate collector with a neat diagram. (K2, PO1)
2. Draw the block diagram of a solar thermal electric plant and explain its working. (K1, PO1)
3. Discuss the effect of temperature and insolation on the characteristics of solar cell. Draw the P-V characteristics of Solar cell under varying temperature and irradiation level. (K3, PO1)

Course Outcome 3 (CO3):

1. Derive the expression for power in the wind turbine. (K1, PO1, PO6, PO7)
2. Classify tidal power plants and brief explain any two of them. (K1, PO1, PO6, PO7)
3. With the help of a block diagram explain the working of a hybrid OTEC. (K2, PO1, PO6, PO7)

Course Outcome 4 (CO4):

1. What are the factors that affect biogas generation? (K1, PO1, PO6, PO7)
2. Compare the construction and performance of floating drum type and fixed dome type biogas plants with the help of neat sketches. (K2, PO1, PO6, PO7)
3. Discuss the selection criteria of turbines for a small hydro project. (K1, PO1, PO6, PO7)

Course Outcome 5 (CO5):

1. What is small hydro power? How is it classified? Obtain an expression for the power that can be generated from a small hydro power station. (K1, PO1)
2. Explain the hydrogen energy system with necessary diagram. (K2, PO1)
3. What do you mean by the conversion efficiency of a fuel cell? (K1, PO1)

Model Question Paper**Total Pages:2**

Reg No.: _____

Name: _____

APJ ABDUL KALAM TECHNOLOGICAL UNIVERSITY**SEVENTH SEMESTER B.TECH DEGREE EXAMINATION****Course Code: EET435****Course Name: RENEWABLE ENERGY SYSTEMS**

Max. Marks: 100

Duration: 3 Hours

PART A*Answer all questions, each carries 3 marks.*

- 1 Differentiate between flat plate collectors and solar concentrators.
- 2 Discuss advantages and limitations of conventional energy sources.
- 3 With the help of a block diagram explain the working of a hybrid OTEC.
- 4 List out the advantages and disadvantages of a tidal power plant.
- 5 Discuss the different types of wind turbine rotors used to extract wind power.
- 6 The Danish offshore wind farm has a name plate capacity of 209.3 MW. As of January 2017 it has produced 6416 GWh since its commissioning 7.3 years ago. Determine the capacity factor of above wind farm.
- 7 What are the factors that affect biogas generation
- 8 Discuss the process of biomass to ethanol conversion
- 9 What are the components of micro hydel power plant.
- 10 Enumerate the design and selection of different types of turbines used for small hydro plants

PART B

Answer any one full question from each module. Each question carries 14 marks

Module 1

- 9 a) With the aid of a neat diagram, explain the working of a central tower collector type solar thermal electric plant (9)
- b) Define (i) Open Circuit Voltage (ii) Short circuit Current (iii) Fill factor and (iv) Efficiency of the solar cell (5)
- 10 a) Compare the components and working of a standalone and grid connected PV system (5)
- b) How energy resources are classified. Compare conventional and non conventional sources of energy resources (9)

Module 2

- 11 What are the site selection criteria for OTEC? Draw the block diagram and explain the working of Anderson cycle based OTEC system. Explain how biofouling affects efficiency of energy conversion and how can it be minimised? (14)
- 12 Explain the principle of operation of a tidal power plant. How it is classified? Draw the layout of a double basin tidal power plant and label all the components. Explain the function of each component (14)

Module 3

- 13 a) Prove that the maximum wind turbine output can be achieved when $V_d = \frac{1}{3}V_u$ (10)
 $V_d = \frac{1}{3}V_u$, where V_d and V_u are down-stream and up-stream wind velocity respectively
- b) What is pitch control of wind turbine? Explain. (4)
- 14 a) Determine the power output of a wind turbine whose blades are 12m in diameter and when the wind speed is 6m/s, the air density is about 1.2kg/m³ and the maximum power coefficient of the wind turbine is 0.35. (5)
- b) Explain the parts, their function and working of a wind power plant. What are the site selection criteria of a wind power plant? (9)

Module 4

- 15 a) With a neat schematic diagram , explain the biomass gasification based electric power generation system (5)
- b) Explain the how urban waste is converted into useful energy (9)
- 16 a) Compare the construction and performance of floating drum type and fixed dome type biogas plants with the help of neat sketches (10)
- b) Explain the importance of biomass programme in India (4)

Module 5

- 15 a) Explain the operation of a phosphoric acid fuel cell with the help of a suitable diagram (7)
- b) What are the different methods used for the production and storage of hydrogen (7)
- 16 a) Draw the layout of a mini hydro project and explain its working (7)
- b) Describe the working and constructional features of PEM fuel cell (7)

Syllabus

Module 1

Introduction, Classification of Energy Resources- Conventional Energy Resources - Availability and their limitations- Non-Conventional Energy Resources – Classification, Advantages, Limitations; Comparison.

SOLAR THERMAL SYSTEMS- Principle of Conversion of Solar Radiation into Heat – Solar thermal collectors. – Flat plate collectors. Solar concentrators (parabolic trough, parabolic dish, Central Tower Collector).

SOLAR ELECTRIC SYSTEMS- Solar Thermal Electric Power Generation – Solar Photovoltaic – Solar Cell fundamentals - characteristics, classification, .construction. Solar PV Systems – stand-alone and grid connected- Applications .

Module 2

ENERGY FROM OCEAN- Ocean Thermal Energy Conversion (OTEC)- Principle of OTEC system- Open Cycle (Claude cycle), Closed Cycle (Anderson cycle) and Hybrid cycle. Site-selection criteria- Biofouling- Advantages & Limitations of OTEC.

TIDAL ENERGY – Principle of Tidal Power- Components of Tidal Power Plant (TPP)- Classification-single basin- double basin types –Limitations -Environmental impacts.

Module 3

WIND ENERGY- Introduction- Basic principles of Wind Energy Conversion Systems (WECS) wind speed measurement-Classification of WECS- types of rotors. wind power equation -Betz limit. Electrical Power Output and Capacity Factor of WECS- Advantages and Disadvantages of WECS -site selection criteria.

Module 4

BIOMASS ENERGY- Introduction- Biomass fuels-Biomass conversion technologies -Urban waste to Energy Conversion- Biomass Gasification- Biomass to Ethanol Production- Biogas production from waste biomass- factors affecting biogas generation-types of biogas plants – KVIC and Janata model-Biomass program in India.

Module 5

SMALL HYDRO POWER- Classification as micro, mini and small hydro projects - Basic concepts and types of turbines- selection considerations.

EMERGING TECHNOLOGIES: Fuel Cell-principle of operation –classification- conversion efficiency and losses - applications .Hydrogen energy -hydrogen production -electrolysis - thermo chemical methods -hydrogen storage and utilization.

Text Books

1. G. D. Rai, “ Non Conventional Energy Sources”, Khanna Publishers, 2010.
2. Rao S. and B. B. Parulekar, Energy Technology, Khanna Publishers, 1999

Reference Books

1. G.N. Tiwari: Solar Energy-Fundamentals, Design, Modelling and Applications, Narosa Publishers, 2002
2. Earnest J. and T. Wizelius, Wind Power Plants and Project Development, PHI Learning, 2011.
3. Sab S. L., Renewable and Novel Energy Sources, MI. Publications, 1995.
4. Sawhney G. S., Non-Conventional Energy Resources, PHI Learning, 2012.
5. Tiwari G. N., Solar Energy- Fundamentals, Design, Modelling and Applications, CRC Press, 2002.
6. A.A.M. Saigh (Ed): Solar Energy Engineering, Academic Press, 1977
7. Abbasi S. A. and N. Abbasi, Renewable Energy Sources and Their Environmental Impact, Prentice Hall of India, 2001..
8. Boyle G. (ed.), Renewable Energy - Power for Sustainable Future, Oxford University Press, 1996

9. Earnest J. and T. Wizelius, Wind Power Plants and Project Development, PHI Learning, 2011.
10. F. Kreith and J.F. Kreider: Principles of Solar Engineering, McGraw Hill, 197
11. F. Kreith and J.F. Kreider: Principles of Solar Engineering, McGraw Hill, 1978 62.
12. Khan B.H, Non Conventional Energy resources Tata McGraw Hill, 2009.

Course Contents and Lecture Schedule

No	Topic	No. of Lectures (35 hours)
1	INTRODUCTION (7 HOURS)	
1.1	Classification of Energy Resources- Conventional Energy - Resources - Availability and their limitations	1
1.2	Non-Conventional Energy Resources – Classification, Advantages, Limitations, Comparison.	1
1.3	SOLAR THERMAL SYSTEMS- Principle of Conversion of Solar Radiation into Heat – Solar thermal collectors.	1
1.4	Flat plate collectors. Solar concentrators (parabolic trough, parabolic dish, Central Tower Collector)	1
1.5	SOLAR ELECTRIC SYSTEMS- Solar Thermal Electric Power Generation	1
1.6	Solar Photovoltaic – Solar Cell fundamentals - characteristics, classification, construction.	1
1.7	Solar PV Systems – stand-alone and grid connected- Applications	1
2	ENERGY FROM OCEAN (7 hours)	
2.1	Ocean Thermal Energy Conversion (OTEC)- Principle of OTEC system-	1
2.2	Open Cycle (Claude cycle), Closed Cycle (Anderson cycle)	1
2.3	Hybrid cycle. Site-selection criteria	1
2.4	Biofouling- Advantages & Limitations of OTEC	1
2.5	TIDAL ENERGY – Principle of Tidal Power- Components of Tidal Power Plant (TPP)-	1
2.6	Classification-single basin- double basin types –Limitations and environmental impacts	2
3	WIND ENERGY (7 hours)	
3.1	Introduction- Basic principles of Wind Energy Conversion Systems (WECS)	1
3.2	Wind speed measurement	1

3.3	Classification of WECS- types of rotors	2
3.4	Wind power equation -Betz limit	1
3.5	Electrical Power Output and Capacity Factor of WECS	1
3.6	Advantages and Disadvantages of WECS -site selection criteria	1
4	BIOMASS ENERGY (6 hours)	
4.1	Urban waste to Energy Conversion	1
4.2	Biomass Gasification- Biomass to Ethanol Production	1
4.3	Biogas production from waste biomass	2
4.4	Types of biogas plants – KVIC and Janata model	1
4.5	Biomass program in India.	1
5	SMALL HYDRO POWER (8 hours)	
5.1	Classification as micro, mini and small hydro projects	1
5.2	Basic concepts and types of turbines- selection considerations.	2
5.3	EMERGING TECHNOLOGIES: Fuel Cell-principle of operation	1
5.4	Classification- conversion efficiency and losses - applications	1
5.5	Hydrogen energy -hydrogen production	1
5.6	Electrolysis -thermo chemical methods	1
5.7	Hydrogen storage and utilization.	1



CODE	COURSE NAME	CATEGORY	L	T	P	CREDIT
EET445	ELECTRIC VEHICLES	OEC	2	1	0	3

Preamble: This course introduces basic knowledge about electric vehicles. Basic knowledge about the drives used in EV and HEV, battery management system, energy sources and communication networks are also discussed.

Prerequisite: NIL.

Course Outcomes: After the completion of the course the student will be able to

CO 1	Explain the basic concept of electric and hybrid electric vehicle
CO 2	Choose proper energy storage systems for vehicle applications
CO 3	Identify various communication protocols and technologies used in vehicle networks

Mapping of course outcomes with program outcomes

	PO 1	PO 2	PO 3	PO 4	PO 5	PO 6	PO 7	PO 8	PO 9	PO 10	PO 11	PO 12
CO 1	2					1	1					1
CO 2	2					1	1					1
CO 3	2					1	1					1

Assessment Pattern

Bloom's Category	Continuous Assessment Tests		End Semester Examination
	1	2	
Remember	10	10	20
Understand	25	25	50
Apply	15	15	30
Analyse			
Evaluate			
Create			

Mark distribution

Total Marks	CIE	ESE	ESE Duration
150	50	100	3 hours

Continuous Internal Evaluation Pattern:

Attendance	: 10 marks
Continuous Assessment Test (2 numbers)	: 25 marks
Assignment/Quiz/Course project	: 15 marks

End Semester Examination Pattern: There will be two parts; Part A and Part B. Part A contain 10 questions with 2 questions from each module, having 3 marks for each question. Students should answer all questions. Part B contains 2 questions from each module of which student should answer any one. Each question can have maximum 2 sub-divisions and carry 14 marks.

Course Level Assessment Questions**Course Outcome 1 (CO1):**

1. List various vehicle performance indices. (K1, PO1, PO6, PO7)
2. List various hybrid electric vehicle topologies.(K1, PO1)
3. Highlight the importance of control of electric motor drives in electric and hybrid electric vehicle powertrains. (K2, PO1, PO6, PO7)

Course Outcome 2 (CO2)

1. State the different characteristics of the energy storage system used in electric and hybrid electric vehicles .(K2, PO1, PO6, PO7)
2. Describe how the battery size can be reduced in electric and hybrid electric vehicles. (K2, PO1, PO6, PO7)
3. Illustrate the different methods used for increasing the battery life in electric and hybrid electric vehicles. (K2, PO1, PO6, PO7)

Course Outcome 3 (CO3):

1. List the general objectives of energy management strategies employed in electric and hybrid electric vehicles. (K1, PO1, PO6, PO7)
2. Identify various communication protocols used in electric and hybrid electric vehicles. (K1, PO1, PO6)
3. Illustrate how fuel economy is maintained in hybrid electric vehicles. (K2, PO1, PO6, PO7)

Model Question Paper**QP CODE:**

PAGES: 3

Reg. No: _____

Name: _____

**APJ ABDUL KALAM TECHNOLOGICAL UNIVERSITY
SEVENTH SEMESTER B.TECH DEGREE EXAMINATION,
MONTH & YEAR****Course Code: EET455****Course Name: Electric Vehicles**

Max. Marks: 100

Duration: 3 Hours

PART A (3 x 10 = 30 Marks)**Answer all Questions. Each question carries 3 Marks**

1. List the reasons that led to the evolution of hybrid electric vehicles.
2. List the characteristics of the transmission system in a vehicle.
3. Mention one instance, when the internal combustion engine shall take up extra torque in the drivetrain of a parallel hybrid while being driven.
4. List major components in the drivetrain of an electric vehicle.
5. Discuss the advantage and disadvantage of using DC motors in the drivetrain of electric and hybrid electric vehicles.
6. List any three motors that can be used in the drivetrain of electric and hybrid electric vehicles.
7. Explain the C-rating of a battery
8. Explain the basic fuel cell structure with the help of a neat diagram
9. What are the seven layers of Open System Interconnection (OSI)?
10. What is meant by CAN transfer protocol

PART B (14 x 5 = 70 Marks)**Answer any one full question from each module. Each question carries 14 Marks****Module 1**

11. Explain the history of electric and hybrid electric vehicles. 14
12. Explain the essential characteristics in the power sources intended to be used in electric and hybrid electric vehicles. 14

Module 2

13. a. Highlight various factors that influence the component sizing in the power trains of hybrid electric vehicles. 7
- b. Illustrate how an internal combustion engine is always operated in its maximum operating efficiency region in a hybrid electric vehicle. 7
14. a. Highlight the limitations posed by the battery during the power flow control in electric drive-train topologies. 8
- b. Suggest various methods to minimize the battery size and maximize battery life during the power flow control in electric drive-train topologies. 6

Module 3

15. a. List the desired characteristics of motors used in the drive trains of electric and hybrid electric vehicles. 7
- b. Demonstrate the control of separately excited DC motors in electric vehicles. 7
16. a. Explain the block diagram of electric drive system used in electric vehicles. 7
- b. Demonstrate the Field Oriented Control of Induction Motors in the powertrain of electric vehicles. 7

Module 4

17. Explain about Lithium ion batteries with the help of necessary diagram. Write the chemical reactions involved in it. 14

18. What are the various battery parameters? Briefly explain 14

Module 5

19. Compare various energy management strategies in electric vehicles. 14
20. Discuss about a typical CAN layout in a hybrid electric vehicle with the help of block diagram 14

Syllabus

Module 1 (6 hrs)

Introduction to Hybrid Electric Vehicles: History of hybrid and electric vehicles, social and environmental importance of hybrid and electric vehicles

Basics of vehicle performance, vehicle power source characterization, transmission characteristics, mathematical models to describe vehicle performance

Module II (8 hrs)

Hybrid Electric Drive-trains: Basic concept of hybrid traction, introduction to various hybrid drive-train topologies, power flow control in hybrid drive-train topologies, Introduction to electric components used in hybrid electric vehicles

Electric Drive-trains: Basic concept of electric traction, introduction to various electric drive-train topologies, power flow control in electric drive-train topologies.

Module III (8 hrs)

Block diagram of electric drive system, Introduction to electric motors used in hybrid and electric vehicles: configuration and control of separately excited DC motors, Induction Motors (block diagram representation of FOC).

Module IV (7 hrs)

Energy Storage: Introduction to Energy Storage Requirements in Hybrid and Electric Vehicles, Battery based energy storage, Fuel Cell based energy storage, Hybridization of different energy storage devices, Introduction to Super capacitor and Hydrogen energy storage.

Module V (7 hrs)

Communications, supporting subsystems: In vehicle networks- CAN

Introduction to energy management strategies used in hybrid and electric vehicles, classification of different energy management strategies, comparison of different energy management strategies

Text/References Books

- 1 Iqbal Hussein, Electric and Hybrid Vehicles: Design Fundamentals, CRC Press, 2003
2. NPTEL (notes) – Electrical Engineering – Introduction to Hybrid and Electric Vehicles
- 3 K Sundareswaran, Elementary Concepts of Power Electronic Drives: CRC Press, Taylor & Francis Group

Course Contents and Lecture Schedule

No	Topic	No. of Lectures
1	Introduction to Hybrid Electric Vehicles (6)	
1.1	History of hybrid and electric vehicles,	1
1.2	Social and environmental importance of hybrid and electric vehicles	1
1.3	Basics of vehicle performance	1
1.4	Vehicle power source characterization, transmission characteristics	1
1.5	Mathematical models to describe vehicle performance	1
1.6	Dynamics of electric motion	1
2	Hybrid Electric Drive -trains and Electric drive trains (8)	
2.1	Basic concept of hybrid traction	1
2.2	Introduction to various hybrid drive-train topologies	1

2.3	Power flow control in hybrid drive-train topologies	2
2.4	Basic concept of electric traction	1
2.5	Introduction to various electric drive-train topologies,	1
2.6	Power flow control in electric drive-train topologies	2
3	Electric drive system in electric and hybrid electric vehicles (8)	
3.1	DC motors and induction motors	2
3.2	Introduction to Electric drive system	2
3.3	Separately excited DC motor speed control	1
3.4	V/f control of induction motor drive	1
3.5	Introduction to vector control (block diagram representation only)	2
4	Introduction to Energy Storage Requirements in Hybrid and Electric Vehicles (7)	
4.1	Battery based energy storage	3
4.2	Fuel Cell based energy storage	2
4.3	Hybridization of different energy storage devices	1

	Introduction to Super capacitor and Hydrogen energy storage	1
5	Communications, supporting subsystems and energy management strategies (7)	
5.1	Communications networks	2
5.2	Introduction to energy management strategies used in hybrid and electric vehicles	1
5.3	Classification of different energy management strategies	2
5.4	Comparison of different energy management strategies	2



CODE	COURSE NAME	CATEGORY	L	T	P	CREDIT
EET455	ENERGY MANAGEMENT	OEC	2	1	0	3

Preamble: This course introduces basic knowledge about energy management and audit. Energy management opportunities in electrical and mechanical systems are discussed. Economic analysis of different energy conservation measures is also described.

Prerequisite: Basics of Mechanical Engineering and Basics of Electrical Engineering.

Course Outcomes: After the completion of the course the student will be able to

CO 1	Explain the significance and procedure for energy management and audit.
CO 2	Discuss the energy efficiency and management of electrical loads.
CO 3	Discuss the energy efficiency in boilers and furnaces.
CO 4	Explain the energy management opportunities in HVAC systems
CO 5	Compute the economic feasibility of the energy conservation measures.

Mapping of course outcomes with program outcomes

	PO 1	PO 2	PO 3	PO 4	PO 5	PO 6	PO 7	PO 8	PO 9	PO 10	PO 11	PO 12
CO 1	2					1	1		2	1		1
CO 2	2					1	1					
CO 3	2					1	1					
CO 4	2					1	1					
CO 5	2					1	1					1

Assessment Pattern

Bloom's Category	Continuous Assessment Tests		End Semester Examination
	1	2	
Remember	25	25	50
Understand	15	15	30
Apply	10	10	20
Analyse			
Evaluate			
Create			

Mark distribution

Total Marks	CIE	ESE	ESE Duration
150	50	100	3 hours

Continuous Internal Evaluation Pattern:

Attendance	: 10 marks
Continuous Assessment Test (2 numbers)	: 25 marks
Assignment/Quiz/Course project	: 15 marks

End Semester Examination Pattern: There will be two parts; Part A and Part B. Part A contain 10 questions with 2 questions from each module, having 3 marks for each question. Students should answer all questions. Part B contains 2 questions from each module of which student should answer any one. Each question can have maximum 2 sub-divisions and carry 14 marks.

Course Level Assessment Questions**Course Outcome 1 (CO1):**

1. Define energy management. (K1, PO1, PO6, PO7)
2. List the different phases involved in energy management planning.(K1)
3. State the need for energy audit. (K2, PO1, PO9, PO10, PO12)

Course Outcome 2 (CO2)

1. State the different methods which can be adopted to reduce energy consumption in lighting.(K2, PO1, PO6, PO7)
2. Describe how energy consumption can be reduced by energy efficient motors.(K2, PO1, PO6, PO7)
3. Illustrate the different methods used for controlling peak demand.(K2, PO1, PO6, PO7)

Course Outcome 3 (CO3):

1. List the energy conservation opportunities in boiler.(K1, PO1)
2. Define Steam trapping.(K1, PO1)
3. Demonstrate how fuel economy measures can be done in furnaces.(K2, PO1, PO6, PO7)

Course Outcome 4 (CO4):

1. Define Coefficient of performance(K1, PO1)
2. Demonstrate how waste heat recovery can be done.(K2, PO1, PO6, PO7)
3. Describe how energy consumption can be reduced by cogeneration.(K2,PO1, PO6, PO7)

Course Outcome 5 (CO5):

1. State the need for economic analysis of energy projects.(K2, PO6, PO7, PO12)
2. Define payback period.(K1, PO12)
3. Demonstrate how life cycle costing approach can be used for comparing energy projects.(K3, PO6, PO7, PO12)

Model Question Paper**QP CODE:**

PAGES: 3

Reg. No: _____

Name: _____

APJ ABDUL KALAM TECHNOLOGICAL UNIVERSITY SEVENTH SEMESTER**B.TECH DEGREE EXAMINATION,****MONTH & YEAR****Course Code: EET455****Course Name: ENERGY MANAGEMENT**

Max. Marks: 100

Duration: 3 Hours

PART A (3 x 10 = 30 Marks)**Answer all Questions. Each question carries 3 Marks**

1. Explain what do you mean by energy audit report.
2. Write notes on building management system.
3. Compare the efficacy of different light sources.
4. Write notes on types of industrial loads.
5. Discuss any two opportunities for energy savings in steam distribution.
6. Explain how boiler efficiency can be assessed using direct method.
7. Explain the working of a waste heat recovery system.
8. Write notes on computer aided energy management.
9. What are the advantages and disadvantages of pay back period method.
10. What do you mean by time value of money?

PART B (14 x 5 = 70 Marks)**Answer any one full question from each module. Each question carries 14 Marks****Module 1**

11. a. With the help of case studies, explain any four energy management principles. 8
- b. Explain the different phases of energy management planning. 6
12. a. Explain in detail the different steps involved in a detailed energy audit. 7
- b. Discuss the different instruments used for energy audit. 7

Module 2

13. a. With the help of case studies, explain any four methods to reduce energy consumption in lighting. 8
- b. Explain how energy efficient motors help in reducing energy consumption. 6
14. a. With the help of case studies, explain any four methods to reduce energy consumption in motors. 8
- b. Explain the different methods used for peak demand control. 6

Module 3

15. a. Explain any four energy conservation opportunities in furnaces. 7
- b. What is meant by a steam trap? Explain the operation of the thermostatic steam trap. 7
16. a. Discuss the different energy conservation opportunities in boilers. 7
- b. Explain in detail, the reasons for low furnace efficiency. 7

Module 4

17. a. Explain any five energy saving opportunities in heating, ventilating and air conditioning systems. 7
- b. Explain the working of different types of cogeneration systems. 7
18. a. Explain the impact of evaporator and condenser temperature on the power consumption of a refrigerator. 7
- b. Explain the working of any two waste heat recovery devices. 7

Module 5

19. a. Calculate the energy saving and payback period which can be achieved by replacing a 11 kW, existing motor with an EEM. The capital investment required for EEM is Rs. 40,000/-. Cost of energy/kWh is Rs. 5. The loading is 70% of the rated value for both motors. Efficiency of the existing motor is 81% and that of EEM is 84.7%. 8
- b. Compare internal rate of return method with present value method for the selection of energy projects. 6
20. a. Explain how the average rate of return method can be used for the selection of energy projects. 6
- b. Compare the following motors based on life cycle costing approach. 8

	Motor A	Motor B
Output rating	10 kW	10 kW
Conversion efficiency	80%	90%
Initial cost	Rs. 50000	Rs. 75000
Replacement life	5 yrs	20 yrs
Salvage value	Rs. 2500	Rs. 3000
Annual maintenance and overhead costs	Rs. 1000	Rs. 1000
Electricity cost	Rs. 5 per kWh	
Operating schedule	8 hrs/day, 22 days/ month	

Syllabus

Module 1 (7 hours)

Energy Management - General Principles and Planning:

General principles of energy management and energy management planning

Energy Audit: Definition, need, types and methodologies. Instruments for energy audit, Energy audit report - Power quality audit

Energy conservation in buildings: ECBC code (basic aspects), Building Management System (BMS).

Module 2 (8 hours)

Energy management in Electricity Utilization:

Energy management opportunities in Lighting and Motors, Electrolytic Process and Electric heating.

Types of industrial loads.

Peak demand controls and methodologies

Module 3 (8 hours)

Energy management in boilers and furnaces:

Types of boilers, Combustion in boilers, Performances evaluation, Feed water treatment, Blow down, Energy conservation opportunities in boiler.

Properties of steam, Assessment of steam distribution losses, Steam leakages, Steam trapping, Condensate and flash steam recovery system, Identifying opportunities for energy savings.

Classification, General fuel economy measures in furnaces, Excess air, Heat Distribution, Temperature control, Draft control.

Module 4 (6 hours)

Energy management in HVAC systems:

HVAC system: Coefficient of performance, Capacity, Factors affecting Refrigeration and Air conditioning system performance and savings opportunities.

Classification and Advantages of Waste Heat Recovery system, analysis of waste heat recovery for Energy saving opportunities

Cogeneration-Types and Schemes, Optimal operation of cogeneration plants- Case study.

Computer aided energy management

Module 5 (6 hours)

Energy Economics:

Economic analysis methods-cash flow model, time value of money, evaluation of proposals, pay-back method, average rate of return method, internal rate of return method, present value method, life cycle costing approach, Case studies.

Text/ Reference Books

1. Albert Thumann, William J. Younger, Handbook of Energy Audits, CRC Press, 2003.
2. Charles M. Gottschalk, Industrial energy conservation, John Wiley & Sons, 1996.
3. Craig B. Smith, Energy management principles, Pergamon Press. 4. D. Yogi Goswami, Frank Kreith, Energy Management and Conservation Handbook, CRC Press, 2007
5. G.G. Rajan, Optimizing energy efficiencies in industry -, Tata McGraw Hill, Pub. Co., 2001.
6. IEEE recommended practice for energy management in industrial and commercial facilities,
7. IEEE std 739 - 1995 (Bronze book).
8. M Jayaraju and Premlet, Introduction to Energy Conservation and Management, Phasor Books, 2008
9. Paul O'Callaghan, Energy management, McGraw Hill Book Co.
10. Wayne C. Turner, Energy management Hand Book - - The Fairmount Press, Inc., 1997.

Course Contents and Lecture Schedule

No	Topic	No. of Lectures
1	Energy Management - General Principles and Planning; Energy audit (7 hours)	
1.1	Energy management; General principles of energy management	2
1.2	Energy management planning	1
1.3	Energy audit: Definition, need, types and methodologies.	2
1.4	Instruments for energy audit, Energy audit report Power quality audit	2
2	Energy management in Electricity Utilization (8 hours)	
2.1	Energy management opportunities in Lighting.	2
2.2	Energy management opportunities in Motors.	2
2.3	Electrolytic Process and Electric heating.	2
2.4	Types of Industrial Loads. Peak Demand controls and Methodologies	2
3	Energy management in boilers and furnaces (8 hours)	
3.1	Types of boilers, Combustion in boilers, Performances evaluation, Feed water treatment, Blow down, Energy conservation opportunities in boiler.	2
3.2	Properties of steam, Assessment of steam distribution losses, Steam leakages, Steam trapping	2
3.3	Condensate and flash steam recovery system, Identifying opportunities for energy savings.	2
3.4	Classification, General fuel economy measures in furnaces, Excess air, Heat Distribution, Temperature control, Draft control, Waste heat recovery.	2
4	Energy management in HVAC systems (6 hours)	
4.1	HVAC system: Coefficient of performance, Capacity	1

4.2	Factors affecting Refrigeration and Air conditioning system performance and savings opportunities.	1
4.3	Classification and Advantages of Waste Heat Recovery system, analysis of waste heat recovery for Energy saving opportunities	2
4.4	Cogeneration-Types and Schemes, Optimal operation of cogeneration plants	2
5	Energy Economics (6 hours)	
5.1	Economic analysis methods	1
5.2	Cash flow model, time value of money, evaluation of proposals	1
5.3	Pay-back method, average rate of return method, internal rate of return method	2
5.4	Present value method, life cycle costing approach, Case studies.	2

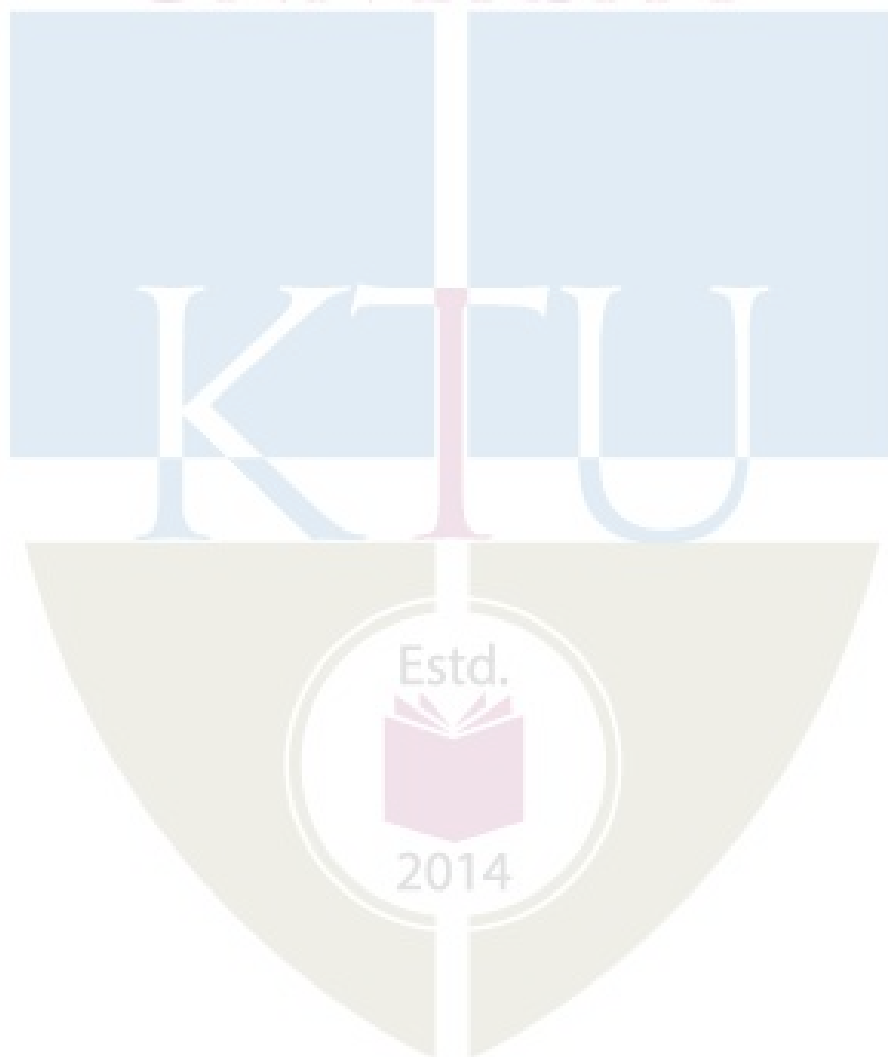

MCN401	INDUSTRIAL SAFETY ENGINEERING	Category	L	T	P	CREDIT
		OEC	2	1	0	3

Preamble: The course is intended to give knowledge of various safety management principles, various safety systems, various machine guarding devices, hazard identification techniques, energy sources, systems & applications and the need in the present context. Learners will be able to compare different hazard identification tools and choose the most appropriate based on the nature of industry. It aims to equip students in working with projects and to take up research work in connected areas

Prerequisite: Nil

Course Outcomes: After the completion of the course the student will be able to

CO1	Describe the theories of accident causation and preventive measures of industrial accidents. (Cognitive Knowledge level: Understand)
CO2	Explain about personal protective equipment, its selection, safety performance & indicators and importance of housekeeping. (Cognitive Knowledge level: Understand)
CO3	Explain different issues in construction industries. (Cognitive Knowledge level: Understand)
CO4	Describe various hazards associated with different machines and mechanical material handling. (Cognitive Knowledge level: Understand)
CO5	Utilise different hazard identification tools in different industries with the knowledge of different types of chemical hazards. (Cognitive Knowledge level: Apply)

Mapping of course outcomes with program outcomes

	PO1	PO2	PO3	PO4	PO5	PO6	PO7	PO8	PO9	PO10	PO11	PO12
CO1	2	2				2	2	2				1
CO2	2	1	2		1	1	1	1				1
CO3	2	2	2		1	1	1	1	1	1		1
CO4	2	2	2		1	1	1	1	1	1		1
CO5	2	2	2	1	1	1	1	1	1	1		1

Abstract POs defined by National Board of Accreditation			
PO1	Engineering Knowledge		PO7 Environment and Sustainability
PO2	Problem Analysis		PO8 Ethics
PO3	Design/Development of solutions		PO9 Individual and team work
PO4	Conduct investigations of complex problems		PO10 Communication
PO5	Modern tool usage		PO11 Project Management and Finance
PO6	The Engineer and Society		PO12 Life long learning

Assessment Pattern

	Continuous Assessment Tests		End Semester Examination
	1	2	
Remember	10	10	10
Understand	20	20	20
Apply	20	20	70
Analyse			
Evaluate			
Create			

Mark distribution:

Total Marks	CIE Marks	ESE Marks	ESE Duration
150	50	100	3 hours

Continuous Internal Evaluation Pattern:

Attendance : 10 marks

Continuous Assessment - Test : 25 marks

Continuous Assessment - Assignment : 15 marks

Internal Examination Pattern:

Each of the two internal examinations has to be conducted out of 50 marks. First series test shall be preferably conducted after completing the first half of the syllabus and the second series test shall be preferably conducted after completing remaining part of the syllabus. There will be two parts: Part A and Part B. Part A contains 5 questions (preferably, 2 questions each from the completed modules and 1 question from the partly completed module), having 3 marks for each question adding up to 15 marks for part A. Students should answer all questions from Part A. Part B contains 7 questions (preferably, 3 questions each from the completed modules and 1 question from the partly completed module), each with 7 marks. Out of the 7 questions, a student should answer any 5.

End Semester Examination Pattern:

There will be two parts; Part A and Part B. Part A contains 10 questions with 2 questions from each module, having 3 marks for each question. Students should answer all questions. Part B contains 2 questions from each module of which a student should answer any one. Each question can have maximum 2 sub-divisions and carries 14 marks.

Syllabus

MCN401- Industrial Safety Engineering (35 hrs)

Module I (safety introduction- 5 hrs)

Need for safety. Safety and productivity. Definitions: Accident, Injury, Unsafe act, Unsafe Condition, Dangerous Occurrence, Reportable accidents. Theories of accident causation. Safety organization- objectives, types, functions, Role of management, supervisors, workmen, unions, government and voluntary agencies in safety. Safety policy. Safety Officer-responsibilities, authority. Safety committee-need, types, advantages.

Module II (Personal protection in work environment- 7 hrs)

Personal protection in the work environment, Types of PPEs, Personal protective equipment- respiratory and non-respiratory equipment. Standards related to PPEs. Monitoring Safety Performance: Frequency rate, severity rate, incidence rate, activity rate. Housekeeping: Responsibility of management and employees. Advantages of good housekeeping. 5 s of housekeeping. Work permit system- objectives, hot work and cold work permits. Typical industrial models and methodology. Entry into confined spaces.

Module III (safety issues in construction- 7 hrs)

Introduction to construction industry and safety issues in construction Safety in various construction operations – Excavation and filling – Under-water works – Under-pinning & Shoring – Ladders & Scaffolds – Tunneling – Blasting – Demolition – Confined space – Temporary Structures. Familiarization with relevant Indian Standards and the National Building Code provisions on construction safety. Relevance of ergonomics in construction safety. Ergonomics Hazards - Musculoskeletal Disorders and Cumulative Trauma Disorders.

Module IV (safety hazards in machines- 8 hrs)

Machinery safeguard-Point-of-Operation, Principle of machine guarding -types of guards and devices. Safety in turning, and grinding. Welding and Cutting-Safety Precautions of Gas

welding and Arc Welding. Material Handling-Classification-safety consideration- manual and mechanical handling. Handling assessments and techniques- lifting, carrying, pulling, pushing, palletizing and stocking. Material Handling equipment-operation & maintenance. Maintenance of common elements-wire rope, chains slings, hooks, clamps. Hearing Conservation Program in Production industries.

Module V (hazard identification and analysis- 8 hrs)

Hazard and risk, Types of hazards –Classification of Fire, Types of Fire extinguishers, fire explosion and toxic gas release, Structure of hazard identification and risk assessment. Identification of hazards: Inventory analysis, Fire and explosion hazard rating of process plants - The Dow Fire and Explosion Hazard Index, Preliminary hazard analysis, Hazard and Operability study (HAZOP) – methodology, criticality analysis, corrective action and follow-up. Control of Chemical Hazards, Hazardous properties of chemicals, Material Safety Data Sheets (MSDS).

Text Books:

1. R.K Jain (2000) Industrial Safety, Health and Environment management systems, Khanna Publications.
2. Paul S V (2000), Safety management System and Documentation training Programme handbook, CBS Publication.
3. Krishnan, N.V. (1997). *Safety management in Industry*. Jaico Publishing House, New Delhi.
4. John V. Grimaldi and Rollin H.Simonds. (1989) *Safety management*. All India Traveller Book Seller, Delhi.
5. Ronald P. Blake. (1973). *Industrial safety*. Prentice Hall, New Delhi.
6. Alan Waring. (1996). *Safety management system*. Chapman & Hall, England.
7. Vaid, K.N., (1988). Construction safety management. National Institute of Construction Management and Research, Mumbai.

8. AIChE/CCPS. (1992). *Guidelines for Hazard Evaluation Procedures*. (second edition). Centre for Chemical Process Safety, American Institute of Chemical Engineers, New York.

Course Level Assessment Questions:

Course Outcome 1 (CO1):

1. Which are the various accident causation theories? Explain.
2. Define terms: Accident, Reportable accident, Dangerous occurrence.

Course Outcome 2 (CO2):

1. Discuss different types of personal protective equipment
2. Discuss about how to compare the safety performance of two industries.
3. Discuss the significance of work permit system in accident prevention.

Course Outcome 3 (CO3):

1. Distinguish ladders and scaffolds along with their safety features.
2. Discuss the safety requirement for a confined space entry.
3. Explain the important provision in the National Building Code.

Course Outcome 4 (CO4):

1. Explain the various principles used in machine guarding.
2. Explain the issues in mechanical material handling.

Course Outcome 5 (CO5):

1. Selection of different types of fire extinguishers accordance to type of fire.
2. Conduct a HAZOP study for a batch reactor of your choice.
3. Determine different types of Chemical hazards associated with industries

MODEL QUESTION PAPER
APJ ABDUL KALAM TECHNOLOGICAL UNIVERSITY
VII SEMESTER B. TECH DEGREE EXAMINATION
MCN401- INDUSTRIAL SAFETY ENGINEERING

Maximum: 100 Marks

Duration: 3 hours

PART A

Answer all questions, each question carries 3 marks

1. Differentiate Unsafe act and Unsafe conditions with suitable examples
2. Discuss the significance of a safety committee in improving the safety performance of an industry
3. Which are the different types of permit? Highlight its suitability.
4. Which are five 'S' used in housekeeping?
5. List the various safety features of ladders.
6. How safety of the workers can be ensured during a demolition operations.
7. Which are the hazards associated with manual material handling?
8. Discuss the safety issues of Gas welding operations.
9. Differentiate Hazard and Risk.
10. Why MSDS is mandatory for chemical products.

(10 X 3 = 30 Marks)

PART B

Answer one full question from each module

Module 1

11. List the various accident causation theories and explain any one in details. (14 Marks)
12. a) Discuss the significance of safety policy in reducing the accidents. (4 Marks)
b) Safety and productivity are the two sides of a coin'. Are you agreeing with this statement? Explain with your arguments. (10 Marks)

Module 2

13. a) Classify the personal protective equipment. List the suitability of at least fifteen types of PPEs. (10 Marks)

b) How will you calculate the frequency rate? Explain with an example. (4 Marks)

14. a) How will you compare the safety performance of two industries? Explain with suitable example. (10 Marks)

b) Which are the steps to be followed in confined space entry to protect the life of a worker. (4 Marks)

Module 3

15. Discuss the safety and fire protection facilities required for a high rise building as per National building code. (14 Marks)

16. a) Identify the various hazards during the different stages of building construction. (7 Marks)

b) Discuss the important types of ergonomic hazards associated with industries. (7 Marks)

Module 4

17. Which are the various types of machine guarding devices used in industries. Discuss the suitability of each machine guarding device. (14 Marks)

18. With suitable sketches briefly explain seven defects of wire ropes. (14 Marks)

Module 5

19. What is Hazard and Operability Analysis? How do you conduct a HAZOP analysis? (14 Marks)

20. Discuss about different types of chemical hazards. (14 Marks)

Course Contents and Lecture Schedule

No.	Topic	No. of Lectures/ Tutorials L-T
1	Introduction to Industrial safety Engineering	
1.1	Need for safety. Safety and productivity. Definitions: Accident, Injury, Unsafe act, Unsafe Condition, Dangerous Occurrence. Reportable accidents	1
1.2	Theories of accident causation. Safety organization.	2
1.3	Role of management, supervisors, workmen, unions, government and voluntary agencies in safety.	3
1.4	Safety Officer-responsibilities, authority.	4
1.5	Safety committee-need, types, advantages.	5
2	Personal protection in the work environment	
2.1	Types of PPEs, respiratory and non-respiratory equipment.	6
2.2	Standards related to PPEs	7
2.3	Monitoring Safety Performance: Frequency rate, severity rate	8,
2.4	Monitoring Safety Performance: incidence rate, activity rate.	9
2.5	Housekeeping: Responsibility of management and employees. Advantages of good housekeeping. 5 s of housekeeping.	10
2.6	Work permit system- objectives, hot work and cold work permits.	11
2.7	Typical industrial models and methodology. Entry into confined spaces.	12
3	Introduction to construction industry and safety	
3.1	Excavation and filling – Under-water works – Under-pinning & Shoring	13
3.2	Ladders & Scaffolds – Tunneling	14
3.3	Blasting –Demolition – Confined space	15
3.4	Familiarization with relevant Indian Standards and the National Building Code provisions on construction safety.	16
3.5	Relevance of ergonomics in construction safety.	17
3.6	Ergonomics Hazards	18
3.7	Musculoskeletal Disorders and Cumulative Trauma Disorders.	19
4	Machinery safeguard	

4.1	Point-of-Operation, Principle of machine guarding -	20
4.2	Types of guards and devices.	21
4.3	Safety in Power Presses, primary & secondary operations - shearing -bending - rolling – drawing.	22
4.4	Safety in turning, boring, milling, planning and grinding.	23
4.5	Welding and Cutting-Safety Precautions of Gas welding and Arc Welding,	24
4.6	Cutting and Finishing.	25
4.7	Material Handling-Classification-safety consideration- manual and mechanical handling. Handling assessments and techniques- lifting, carrying, pulling, pushing, palletizing and stocking.	26
4.8	Material Handling equipment-operation & maintenance. Maintenance of common elements-wire rope, chains slings, hooks, clamps	27
5	Hazard identification	
5.1	Hazard and risk, Types of hazards – Classification of Fire	28
5.2	Types of Fire extinguishers fire, explosion and toxic gas release.	29
5.3	Inventory analysis, Fire and explosion hazard rating of process plants -	30
5.4	The Dow Fire and Explosion Hazard Index.	31
5.5	Preliminary hazard analysis, Hazard and Operability study (HAZOP)	32
5.6	Chemical hazard- Classifications, Control of Chemical Hazards.	33
5.7	Hazardous properties of chemicals	34
5.8	Material Safety Data Sheets (MSDS).	35

EEL411	CONTROL SYSTEMS LAB	CATEGORY	L	T	P	CREDIT
		PCC	0	0	3	2

Preamble: This Laboratory Course provides a platform for modelling and analysis of linear and nonlinear systems with the help of hardware and software tools in the control framework.

Prerequisite: EET302 Linear Control Systems, EET305 Signals and Systems

Course Outcomes: After the completion of the course the student will be able to

CO 1	Demonstrate the knowledge of simulation tools for control system design.
CO 2	Develop the mathematical model of a given physical system by conducting appropriate experiments.
CO 3	Analyse the performance and stability of physical systems using classical and advanced control approaches.
CO 4	Design controllers for physical systems to meet the desired specifications.

Mapping of course outcomes with program outcomes

	PO 1	PO 2	PO 3	PO 4	PO 5	PO 6	PO 7	PO 8	PO 9	PO 10	PO 11	PO 12
CO 1	3	3	2	3	3			3	3	3		3
CO 2	3	3	3	3	3			3	3	3		3
CO 3	3	3	3	3	3			3	3	3		3
CO 4	3	3	3	3	3			3	3	3		3

Assessment Pattern

Mark distribution

Total Marks	CIE	ESE	ESE Duration
-------------	-----	-----	--------------

150	75	75	3 hours
-----	----	----	---------

Continuous Internal Evaluation Pattern:

Attendance : 15 marks

Continuous Assessment : 30 marks

Internal Test : 30 marks

End Semester Examination Pattern: The following guidelines should be followed regarding award of marks

(a) Preliminary work : 15 Marks

(b) Implementing the work/Conducting the experiment : 10 Marks

(c) Performance, result and inference (usage of equipments and troubleshooting) : 25 Marks

(d) Viva voce : 20 marks

(e) Record : 5 Marks

General instructions:

Practical examination to be conducted immediately after the second series test after completing 12 experiments out of the 18 experiments given below. Evaluation is a serious process that is to be conducted under the equal responsibility of both the internal and external examiners. The number of candidates evaluated per day should not exceed 20. Students shall be allowed for the University examination only on submitting the duly certified record. The external examiner shall endorse the record.

Reference Books

1. Richard C. Dorf and Robert H. Bishop, Modern Control Systems, Eleventh Edition, Pearson Education 2009.
2. Katsuhiko Ogatta, Modern Control Engineering, Fourth Edition, Pearson Education, 2002.

List of Exercises/Experiments: (Lab experiments may be given considering 12 sessions of 3 hours each.)

1. Simulation tools like MATLAB/ SCILAB or equivalent may be used.
2. All experiments done by the students in addition to 12 experiments may be treated as beyond syllabus experiments.

Experiment No.	Name of the experiment
1	<p>Step response of a second order system.</p> <p>Objective: Design a second order system (eg: RLC network) to analyse the following:</p> <ul style="list-style-type: none"> A. The effect of damping factor (ξ: 0, <1,=1,>1) on the unit step response using simulation study (M-File and SIMULINK). B. Verification of the delay time, rise time, peak overshoot and settling time with the theoretical values. C. Performance analysis of hardware setup and comparison with the simulation results.
2	<p>Performance Analysis using Root-Locus Method.</p> <p>Objective: Plot the root locus of the given transfer function to analyse the following using simulation:</p> <ul style="list-style-type: none"> A. Verification of the critical gain, w_o with the theoretical values B. The effect of controller gain K on the stability C. The sensitivity analysis by giving small perturbations in given poles and zeros D. The effect of the addition of poles and zeros on the given system.

3	<p align="center">Stability Analysis by Frequency Response Methods.</p> <p>Objective: Plot the i) Bode plot and ii) Nyquist plot of the given transfer functions to analyse the following using simulation:</p> <ul style="list-style-type: none"> A. Determination of Gain Margin and Phase Margin B. Verification of GM and PM with the theoretical values C. The effect of controller gain K on the stability, D. The effect of the addition of poles and zeros on the given system (especially the poles at origin).
4	<p>Realisation of lead compensator.</p> <p>Objective: Design, set up and analyse the gain and phase plots of a lead compensator by hardware experimentation using i) passive elements and ii) active components..</p>
5	<p>Realisation of lag compensator.</p> <p>Objective: Design, set up and analyse the gain and phase plots of a lag compensator by hardware experimentation using i) passive elements and ii) active components..</p>
6	<p>Design of compensator in frequency domain and time domain.</p> <p>Objective: Design a compensator for the given system to satisfy the given specifications</p> <ul style="list-style-type: none"> A. Time domain specifications using MATLAB B. Frequency domain specifications using MATLAB
7	<p>State space model for analysis and design</p> <p>Objective: Study and analysis of state variable model of a given system (eg. DC Motor speed control/ Servo motor/etc) and design a controller by pole-placement technique using MATLAB based tool boxes.</p> <ul style="list-style-type: none"> A. Determine the open loop stability, controllability and observability B. Analyse the effect of system parameters on eigen values and system performance.

C. Design a controller by pole-placement technique.

8	<p>PID Controller Design</p> <p>Objective: Design and analysis of a PID controller for a given system (eg. DC Motor speed control/ Servo motor/etc) using SIMULINK/ MATLAB based tool boxes</p> <p>A. Design of PID controller to meet the given specifications</p> <p>B. Study the effect of tuning of PID controller on the above system.</p>
9	<p>Phase plane analysis of nonlinear autonomous systems</p> <p>Objective: Study and analysis of phase trajectory of a given nonlinear autonomous system using state space model in Simulation tools.</p> <p>A. Determination and verification of the singular points,</p> <p>B. Stability Analysis of the system at various singular points from phase portraits.</p>
10	<p>Transfer Function of Armature and Field Controlled DC Motor</p> <p>Objective: Obtain the transfer function of the armature and field controlled DC motor by experiment.</p>
11	<p>Synchro Transmitter and Receiver.</p> <p>Objective: Plot and study the different performance characteristics of Synchro transmitter- receiver units in Direct mode and Differential mode.</p>
12	<p>Transfer function of Separately excited DC Generator.</p> <p>Objective: Obtain the open loop transfer function of a separately excited DC Generator by experiment.</p>

13	Transfer function of A.C. Servo motor. Objective: Obtain the open loop transfer function of AC Servo motor by experiment.
14	Performance of a typical process control system Objective: Study of performance characteristics and response analysis of a typical temperature/ Flow/ Level control system.
15	Closed loop performance of inverted pendulum. Objective: Study of performance characteristics of inverted pendulum by experiment. A. Determine the various unknown parameters of an inverted pendulum experimentally, B. Obtain and analyse the non-linear and linearised models, C. Design and implement various state feedback controllers to analyse the performance of the system.
16	Performance analysis of magnetic levitation system. Objective: Study of performance of magnetic levitation system by experiment. A. Obtain and analyse the dynamics of a magnetic levitation system, B. Design and implement various loop controllers to analyse the performance of this experimental system while tracking in presence/absence of disturbances.
17	Closed loop performance of Twin rotor system Objective: Study of performance characteristics of Twin rotor system by experiment.

Mass Spring Damper system

Objective: Study of performance characteristics of Mass-Damper-Spring system by experiment.

18

- A. Determine the various unknown parameters of a mass spring damper system experimentally to obtain transfer function/ state space models,
- B. Design and implement various state feedback controllers to analyse the performance of the system while regulation and tracking

APJ ABDUL KALAM
TECHNOLOGICAL
UNIVERSITY

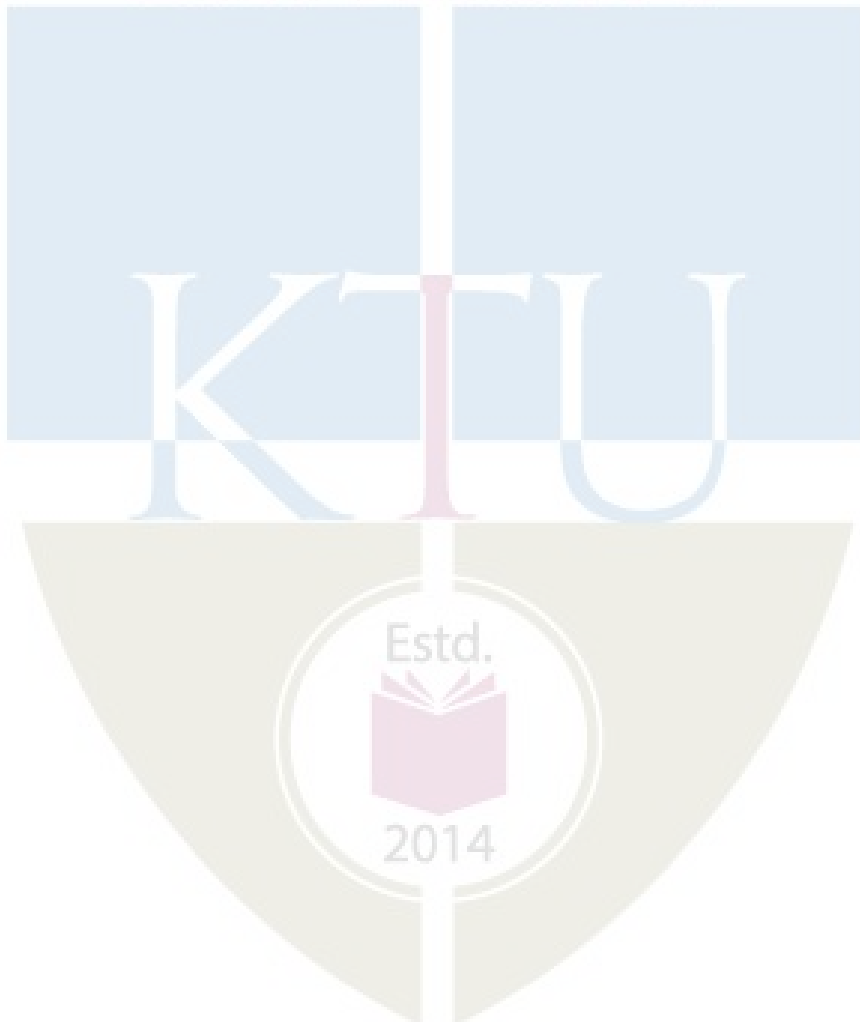

EEQ413	SEMINAR	CATEGORY	L	T	P	CREDIT
		PWS	0	0	3	2

Preamble: The course ‘Seminar’ is intended to enable a B.Tech graduate to read, understand, present and prepare report about an academic document. The learner shall search in the literature including peer reviewed journals, conference, books, project reports etc., and identify an appropriate paper/thesis/report in her/his area of interest, in consultation with her/his seminar guide. This course can help the learner to experience how a presentation can be made about a selected academic document and also empower her/him to prepare a technical report.

Course Objectives:

- To do literature survey in a selected area of study.
- To understand an academic document from the literature and to give a presentation about it.
- To prepare a technical report.

Course Outcomes [COs] : After successful completion of the course, the students will be able to:

CO1	Identify academic documents from the literature which are related to her/his areas of interest (Cognitive knowledge level: Apply).
CO2	Read and apprehend an academic document from the literature which is related to her/ his areas of interest (Cognitive knowledge level: Analyze).
CO3	Prepare a presentation about an academic document (Cognitive knowledge level: Create).
CO4	Give a presentation about an academic document (Cognitive knowledge level: Apply).
CO5	Prepare a technical report (Cognitive knowledge level: Create).

Mapping of course outcomes with program outcomes:

	PO1	PO2	PO3	PO4	PO5	PO6	PO7	PO8	PO9	PO10	PO11	PO12
CO1	2	2	1	1		2	1					3
CO2	3	3	2	3		2	1					3
CO3	3	2			3			1		2		3
CO4	3				2			1		3		3
CO5	3	3	3	3	2	2		2		3		3

Abstract POs defined by National Board of Accreditation

PO#	Broad PO	PO#	Broad PO
PO1	Engineering Knowledge	PO7	Environment and Sustainability
PO2	Problem Analysis	PO8	Ethics
PO3	Design/Development of solutions	PO9	Individual and team work
PO4	Conduct investigations of complex problems	PO10	Communication
PO5	Modern tool usage	PO11	Project Management and Finance
PO6	The Engineer and Society	PO12	Life long learning

General Guidelines

- The Department shall form an Internal Evaluation Committee (IEC) for the seminar with academic coordinator for that program as the Chairperson/Chairman and seminar coordinator & seminar guide as members. During the seminar presentation of a student, all members of IEC shall be present.
- Formation of IEC and guide allotment shall be completed within a week after the University examination (or last working day) of the previous semester.
- Guide shall provide required input to their students regarding the selection of topic/paper.
- Choosing a seminar topic: The topic for a UG seminar should be current and broad based rather than a very specific research work. It's advisable to choose a topic for the Seminar to be closely linked to the final year project area. Every member of the project team could choose or be assigned Seminar topics that covers various aspects linked to the Project area.
- A topic/paper relevant to the discipline shall be selected by the student during the semester break.
- Topic/Paper shall be finalized in the first week of the semester and shall be submitted to the IEC.
- The IEC shall approve the selected topic/paper by the second week of the semester.
- Accurate references from genuine peer reviewed published material to be given in the report and to be verified.

Evaluation pattern

Total marks: 100, only CIE, minimum required to pass 50

Seminar Guide: 20 marks (Background Knowledge – 10 (The guide shall give deserving marks for a candidate based on the candidate's background knowledge about the topic selected), Relevance of the paper/topic selected – 10).

Seminar Coordinator: 20 marks (Seminar Diary – 10 (Each student shall maintain a seminar diary and the guide shall monitor the progress of the seminar work on a weekly basis and shall approve the entries in the seminar diary during the weekly meeting with the student), Attendance – 10).

Presentation: 40 marks to be awarded by the IEC (Clarity of presentation – 10, Interactions – 10 (to be based on the candidate's ability to answer questions during the interactive session of her/his presentation), Overall participation – 10 (to be given based on her/his involvement during interactive sessions of presentations by other students), Quality of the slides – 10).

Report: 20 marks to be awarded by the IEC (check for technical content, overall quality, templates followed, adequacy of references etc.).



EED415	PROJECT PHASE I	CATEGORY	L	T	P	CREDIT
		PWS	0	0	6	2

Preamble: The course ‘Project Work’ is mainly intended to evoke the innovation and invention skills in a student. The course will provide an opportunity to synthesize and apply the knowledge and analytical skills learned, to be developed as a prototype or simulation. The project extends to 2 semesters and will be evaluated in the 7th and 8th semester separately, based on the achieved objectives. One third of the project credits shall be completed in 7th semester and two third in 8th semester. It is recommended that the projects may be finalized in the thrust areas of the respective engineering stream or as interdisciplinary projects. Importance should be given to address societal problems and developing indigenous technologies.

Course Objectives

- To apply engineering knowledge in practical problem solving.
- To foster innovation in design of products, processes or systems.
- To develop creative thinking in finding viable solutions to engineering problems.

Course Outcomes [COs] :After successful completion of the course, the students will be able to:

CO1	Model and solve real world problems by applying knowledge across domains (Cognitive knowledge level: Apply).
CO2	Develop products, processes or technologies for sustainable and socially relevant applications (Cognitive knowledge level: Apply).
CO3	Function effectively as an individual and as a leader in diverse teams and to comprehend and execute designated tasks (Cognitive knowledge level: Apply).
CO4	Plan and execute tasks utilizing available resources within timelines, following ethical and professional norms (Cognitive knowledge level: Apply).
CO5	Identify technology/research gaps and propose innovative/creative solutions (Cognitive knowledge level: Analyze).
CO6	Organize and communicate technical and scientific findings effectively in written and oral forms (Cognitive knowledge level: Apply).

Mapping of course outcomes with program outcomes

	PO1	PO2	PO3	PO4	PO5	PO6	PO7	PO8	PO9	PO10	PO11	PO12
CO1	2	2	2	1	2	2	2	1	1	1	1	2
CO2	2	2	2		1	3	3	1	1		1	1
CO3									3	2	2	1
CO4					2			3	2	2	3	2
CO5	2	3	3	1	2							1
CO6					2			2	2	3	1	1

Abstract POs defined by National Board of Accreditation			
PO#	Broad PO	PO#	Broad PO
PO1	Engineering Knowledge	PO7	Environment and Sustainability
PO2	Problem Analysis	PO8	Ethics
PO3	Design/Development of solutions	PO9	Individual and team work
PO4	Conduct investigations of complex problems	PO10	Communication
PO5	Modern tool usage	PO11	Project Management and Finance
PO6	The Engineer and Society	PO12	Lifelong learning

PROJECT PHASE I

Phase 1 Target

- Literature study/survey of published literature on the assigned topic
- Formulation of objectives
- Formulation of hypothesis/ design/ methodology
- Formulation of work plan and task allocation.
- Block level design documentation
- Seeking project funds from various agencies
- Preliminary Analysis/Modeling/Simulation/Experiment/Design/Feasibility study
- Preparation of Phase 1 report

Evaluation Guidelines & Rubrics

Total: 100 marks (Minimum required to pass: 50 marks).

- Project progress evaluation by guide: 30 Marks.
- Interim evaluation by the Evaluation Committee: 20 Marks.
- Final Evaluation by the Evaluation Committee: 30 Marks.
- Project Phase - I Report (By Evaluation Committee): 20 Marks.

(The evaluation committee comprises HoD or a senior faculty member, Project coordinator and project supervisor).

Evaluation by the Guide

ELECTRICAL AND ELECTRONICS

The guide/supervisor shall monitor the progress being carried out by the project groups on a regular basis. In case it is found that progress is unsatisfactory it shall be reported to the Department Evaluation Committee for necessary action. The presence of each student in the group and their involvement in all stages of execution of the project shall be ensured by the guide. Project evaluation by the guide: 30 Marks. This mark shall be awarded to the students in his/her group by considering the following aspects:

Topic Selection: innovativeness, social relevance etc. (2)

Problem definition: Identification of the social, environmental and ethical issues of the project problem. (2)

Purpose and need of the project: Detailed and extensive explanation of the purpose and need of the project. (3)

Project Objectives: All objectives of the proposed work are well defined; Steps to be followed to solve the defined problem are clearly specified. (2)

Project Scheduling & Distribution of Work among Team members: Detailed and extensive Scheduling with timelines provided for each phase of project. Work breakdown structure well defined. (3)

Literature survey: Outstanding investigation in all aspects. (4)

Student's Diary/ Daily Log: The main purpose of writing daily diary is to cultivate the habit of documenting and to encourage the students to search for details. It develops the students' thought process and reasoning abilities. The students should record in the daily/weekly activity diary the day to day account of the observations, impressions, information gathered and suggestions given, if any. It should contain the sketches & drawings related to the observations made by the students. The daily/weekly activity diary shall be signed after every day/week by the guide. (7)

Individual Contribution: The contribution of each student at various stages. (7)

2014

EVALUATION RUBRICS for PROJECT Phase I: Interim Evaluation

No.	Parameters	Marks	Poor	Fair	Very Good	Outstanding
1-a	Topic identification, selection, formulation of objectives and/or literature survey. (Group assessment) [CO1]	10	The team has failed to come with a relevant topic in time. Needed full assistance to find a topic from the guide. They do not respond to suggestions from the evaluation committee and/or the guide. No literature review was conducted. The team tried to gather easy information without verifying the authenticity. No objectives formed yet.	The team has identified a topic. The originally selected topic lacks substance and needs to be revised. There were suggestions given to improve the relevance and quality of the project topic. Only a few relevant references were consulted/ studied and there is no clear evidence to show the team's understanding on the same. Some objectives identified, but not clear enough.	Good evidence of the group thinking and brainstorming on what they are going to build. The results of the brainstorming are documented and the selection of topic is relevant. The review of related references was good, but there is scope of improvement. Objectives formed with good clarity, however some objectives are not realistic enough.	The group has brainstormed in an excellent manner on what they were going to build. The topic selected is highly relevant, real world problem and is potentially innovative. The group shows extreme interest in the topic and has conducted extensive literature survey in connection with the topic. The team has come up with clear objectives which are feasible.
			(0 – 3 Marks)	(4 – 6 Marks)	(7 - 9 Marks)	(10 Marks)
1-b	Project Planning, Scheduling and Resource/ Tasks Identification and allocation. (Group assessment) [CO4]	10	No evidence of planning or scheduling of the project. The students did not plan what they were going to build or plan on what materials / resources to use in the project. The students do not have any idea on the budget required. The team has not yet decided on who does what. No project journal kept.	Some evidence of a primary plan. There were some ideas on the materials /resources required, but not really thought out. The students have some idea on the finances required, but they have not formalized a budget plan. Schedules were not prepared. The project journal has no details. Some evidence on task allocation among the team members.	Good evidence of planning done. Materials were listed and thought out, but the plan wasn't quite complete. Schedules were prepared, but not detailed, and needs improvement. Project journal is presented but it is not complete in all respect / detailed. There is better task allocation and individual members understand about their tasks. There is room for improvement.	Excellent evidence of enterprising and extensive project planning. Gantt charts were used to depict detailed project scheduling. A project management/version control tool is used to track the project, which shows familiarity with modern tools. All materials / resources were identified and listed and anticipation of procuring time is done. Detailed budgeting is done. All tasks were identified and incorporated in the schedule. A well-kept project journal shows evidence for all the above, in addition to the interaction with the project guide. Each member knows well about their individual tasks.
			(0 – 3 Marks)	(4 – 6 Marks)	(7 - 9 Marks)	(10 Marks)
Phase 1 Interim Evaluation Total Marks: 20						

EVALUATION RUBRICS for PROJECT Phase I: Final Evaluation

Sl. No.	Parameters	Marks	Poor	Fair	Very Good	Outstanding
1-c	Formulation of Design and/or Methodology and Progress. (Group assessment) [CO1]	5	None of the team members show any evidence of knowledge about the design and the methodology adopted till now/ to be adopted in the later stages. The team has not progressed from the previous stage of evaluation.	The students have some knowledge on the design procedure to be adopted, and the methodologies. However, the team has not made much progress in the design, and yet to catch up with the project plan.	The students are comfortable with design methods adopted, and they have made some progress as per the plan. The methodologies are understood to a large extent.	Shows clear evidence of having a well- defined design methodology and adherence to it. Excellent knowledge in design procedure and its adaptation. Adherence to project plan is commendable.
			(0 – 1 Marks)	(2 – 3 Marks)	(4 Marks)	(5 Marks)
1-d	Individual and Teamwork Leadership (Individual assessment) [CO3]	10	The student does not show any interest in the project activities, and is a passive member.	The student show some interest and participates in some of the activities. However, the activities are mostly easy and superficial in nature.	The student shows very good interest in project, and takes up tasks and attempts to complete them. Shows excellent responsibility and team skills. Supports the other members well.	The student takes a leadership position and supports the other team members and leads the project. Shows clear evidence of leadership.
			(0 – 3 Marks)	(4 – 6 Marks)	(7 - 9 Marks)	(10 Marks)
1-e	Preliminary Analysis/ Modeling / Simulation/ Experiment / Design/ Feasibility study [CO1]	10	The team has not done any preliminary work with respect to the analysis/modeling/ simulation/experiment/design/feasibility study/ algorithm development.	The team has started doing some preliminary work with respect to the project. The students however are not prepared enough for the work and they need to improve a lot.	There is some evidence to show that the team has done good amount of preliminary investigation and design/ analysis/ modeling etc. They can improve further.	Strong evidence for excellent progress in the project. The team has completed the required preliminary work already and are poised to finish the phase I in an excellent manner. They have shown results to prove their progress.
			(0 – 3 Marks)	(4 – 6 Marks)	(7 - 9 Marks)	(10 Marks)

1-f	Documentation and presentation. (Individual & group assessment). [CO6]	5	<p>The team did not document the work at all. The project journal/diary is not presented. The presentation was shallow in content and dull in appearance. The individual student has no idea on the presentation of his/her part.</p>	<p>Some documentation is done, but not extensive. Interaction with the guide is minimal. Presentation include some points of interest, but overall quality needs to be improved. Individual performance to be improved.</p>	<p>Most of the project details were documented well enough. There is scope for improvement. The presentation is satisfactory. Individual performance is good.</p>	<p>The project stages are extensively documented in the report. Professional documentation tools like LaTeX were used to document the progress of the project along with the project journal. The documentation structure is well-planned and can easily grow into the project report.</p> <p>The presentation is done professionally and with great clarity. The individual's performance is excellent.</p>
			(0 – 1 Marks)	(2 – 3 Marks)	(4 Marks)	(5 Marks)
Total		30	Phase - I Final Evaluation Marks: 30			

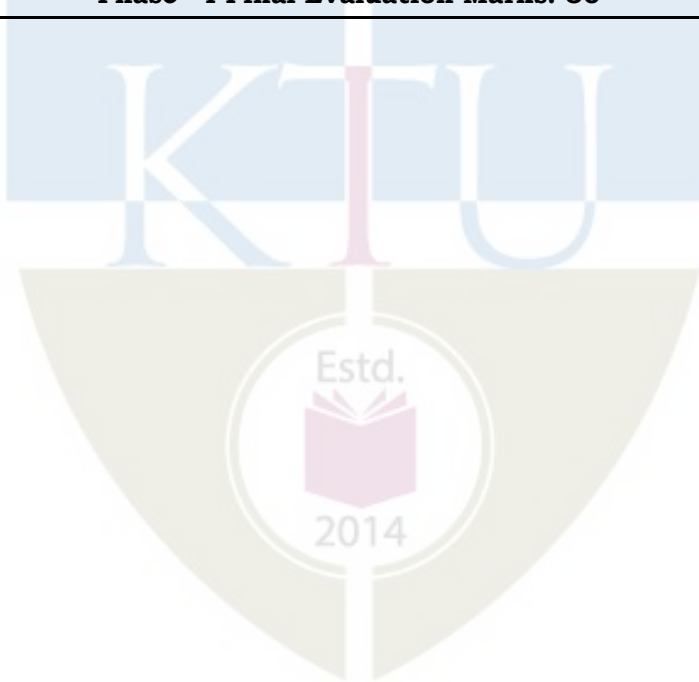

EVALUATION RUBRICS for PROJECT Phase I: Report Evaluation

Sl. No.	Parameters	Marks	Poor	Fair	Very Good	Outstanding
1-g	Report [CO6]	20	The prepared report is shallow and not as per standard format. It does not follow proper organization. Contains mostly Unacknowledged content. Lack of effort in preparation is evident.	Project report follows the standard format to some extent. However, its organization is not very good. Language needs to be improved. All references are not cited properly in the report.	Project report shows evidence of systematic documentation. Report is following the standard format and there are only a few issues. Organization of the report is good. Most of references are cited properly.	The report is exceptionally good. Neatly organized. All references cited properly. Diagrams/Figures, Tables and equations are properly numbered, and listed and clearly shown. Language is excellent and follows standard styles.
			(0 - 7 Marks)	(8 - 12 Marks)	(13 - 19 Marks)	(20 Marks)
Phase - I Project Report Marks: 20						

